

CAN ART

ALUMINUM EXTRUSION

OPEN SHAPES CATALOGUE

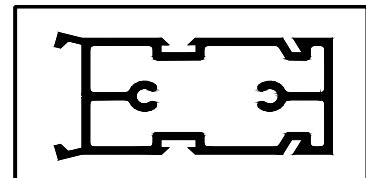
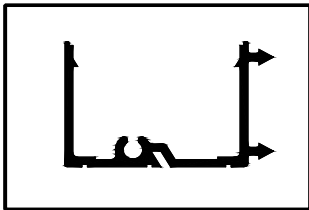

BRAMPTON PLANT
85 Parkshore Dr.
Brampton, Ont L6T 5M1
Tel. No. (905) 791-1464
Fax No. (905) 791-9151

www.canart.com

WINDSOR PLANT
428 Jutras Dr.
Windsor, Ont N8N 5C5
Tel. No. (519) 727-4399
Fax No. (519) 727-6434

TABLE OF CONTENTS

SECTION 1 – OPEN SHAPES

CHAPTER 1 - DOOR SHAPES

STORM DOORS AND WINDOWS.....	100
RESIDENTIAL DOOR THRESHOLDS.....	110
PATIO DOOR SHAPES.....	120

CHAPTER 2 - WINDOW SHAPES

GP2 WINDOW.....	210
MISCELLANEOUS WINDOW SHAPES.....	220

CHAPTER 3 – ARCHITECTURAL SHAPES

CURTAIN WALL.....	300
PRESSURE PLATES, CAPS AND SPIGOTS.....	310
ENTRANCE WAYS	320
COMMERCIAL DOORS	340

CHAPTER 4 – MISCELLANEOUS SHAPES

SIGN SHAPES.....	400
STREET SIGNS.....	410
CABLE TRAY AND POWER ACCESSORIES.....	500
GREENHOUSE SHAPES.....	700
HOUSEBOAT SHAPES	800
SCHOOL PRODUCTS.....	900
R.V. SHAPES.....	1000
DOCK SHAPES.....	1200
RAMP SHAPES.....	1300
FENCING AND RAILING SHAPES.....	1400
MISCELLANEOUS	1500

SECTION 2 – ASSEMBLY DRAWINGS

1-3/4” STORM DOOR ASSEMBLY.....	100-A
GP2 WINDOW ASSEMBLY.....	210-A
2” CURTAIN WALL ASSEMBLY.....	300-A
2-1/2” CURTAIN WALL ASSEMBLY	300-B
4-1/2” x 1-3/4” FLUSHLINE ASSEMBLY	340-A
4” B-TUBE ASSEMBLY w/ 1/2” FIN	320-B
COMMERCIAL DOOR ASSEMBLY	320-A

SECTION 1







OPEN SHAPES

CHAPTER 1

DOOR SHAPES

STORM DOORS AND WINDOWS

100

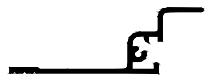
DRAWING	DESCRIPTION	DIE NUMBER	LBS/FT	KG/M
	0.862 x 0.425 BACK-UP ANGLE WALL = 0.050 (1.27)	ES05027	0.071	0.105
	0.506 x 0.542 CHANNEL WALL = 0.045 (1.14)	ES05028	0.082	0.122
	1.395 x 0.625 HINGE WALL = 0.085 (2.16)	ES05948	0.198	0.295
	0.697 x 0.290 SASH RAIL WALL = 0.045 (1.14)	ES06486	0.106	0.157
	0.750 x 0.300 SCREEN RAIL WALL = 0.062 (1.57)	ES07624	0.109	0.163
	0.433 x 0.609 INTERLOCK WALL = 0.050 (1.27)	ES07625	0.112	0.167
	0.487 x 0.734 GLASS MEETING RAIL WALL = 0.050 (1.27)	ES07627	0.145	0.216
	2.454 x 0.892 STORM WINDOW FRAME WALL = 0.050 (1.27)	ES09705	0.255	0.379
NOTES:				





STORM DOORS AND WINDOWS

100

DRAWING	DESCRIPTION	DIE NUMBER	LBS/FT	KG/M
	<p>2.485 x 0.882 BOTTOM FRAME WALL = 0.045 (1.14)</p>	<p>ES09808</p>	<p>0.241</p>	<p>0.358</p>
<p>NOTES:</p>				

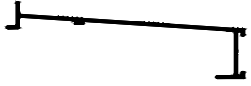
RESIDENTIAL DOOR THRESHOLDS

110

DRAWING	DESCRIPTION	DIE NUMBER	LBS/FT	KG/M
	<p>4.726 x 1.650 6" PATIO SILL WALL = 0.065 (1.65)</p>	<p>ES06527</p>	<p>0.553</p>	<p>0.822</p>
	<p>2.140 x 1.063 2" SILL EXTENSION WALL = 0.062 (1.57)</p>	<p>ES07539</p>	<p>0.345</p>	<p>0.513</p>
	<p>4.625 x 0.500 THERMALLY BROKEN SILL WALL = 0.080 (2.03)</p>	<p>ES08737</p>	<p>0.719</p>	<p>1.071</p>
	<p>6.625 x 0.500 THERMALLY BROKEN SILL WALL = 0.080 (2.03)</p>	<p>ES08738</p>	<p>0.943</p>	<p>1.404</p>

NOTES:

PATIO DOOR SHAPES

120

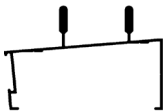
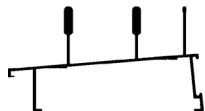
DRAWING	DESCRIPTION	DIE NUMBER	LBS/FT	KG/M
	<p>1.420 x 1.420 STILE REINFORCEMENT WALL = 0.050 (1.27)</p>	<p>EH09440</p>	<p>0.323</p>	<p>0.481</p>
	<p>3.375 x 2.417 INTERIOR SILL WALL = 0.062 (1.62)</p>	<p>ES16554</p>	<p>0.816</p>	<p>1.215</p>
	<p>3.999 x 2.351 EXTERIOR SILL WALL = 0.062 (1.57)</p>	<p>ES16555</p>	<p>0.944</p>	<p>1.404</p>





NOTES:

CHAPTER 2

WINDOW SHAPES

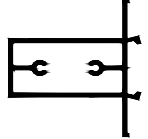
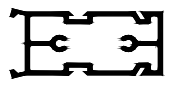





GP2 WINDOW

210

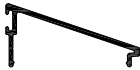
DRAWING	DESCRIPTION	DIE NUMBER	LBS/FT	KG/M
	<p>4.837 x 0.910 SILL WALL = 0.062 (1.57)</p>	<p>ES05106</p>	<p>0.579</p>	<p>0.862</p>
	<p>1.885 x 2.374 EXT. MULLION WALL = 0.062 (1.57)</p>	<p>EH05125</p>	<p>0.665</p>	<p>0.990</p>
	<p>2.001 x 1.000 INT. MULLION WALL = 0.062 (1.57)</p>	<p>EH05128</p>	<p>0.663</p>	<p>0.987</p>
	<p>0.978 x 0.870 EXT. CHANNEL WALL = 0.062 (1.57)</p>	<p>ES05133</p>	<p>0.191</p>	<p>0.284</p>
	<p>0.800 x 0.318 SCREEN RAIL WALL = 0.050 (1.27)</p>	<p>EH05134</p>	<p>0.114</p>	<p>0.170</p>
	<p>4.750 x 2.174 SILL FLASHING WALL = 0.070 (1.78)</p>	<p>ES13188</p>	<p>0.560</p>	<p>0.834</p>
<p>NOTES:</p>				

MISCELLANEOUS WINDOW SHAPES

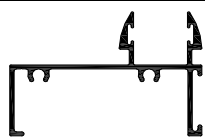

220

DRAWING	DESCRIPTION	DIE NUMBER	LBS/FT	KG/M
	1.126 x 0.449 SASH WALL = 0.063 (1.60)	ES15953	0.222	0.330
	1.750 x 0.890 GLASS STOP WALL = 0.050 (1.27)	ES16064	0.208	0.309
	2.940 x 1.000 PERIMETER FRAME WALL = 0.062 (1.52)	ES16065	0.484	0.720
	1.126 x 0.925 MEETING RAIL WALL = 0.063 (1.60)	ES16066	0.302	0.450
	1.195 x 1.124 PULL RAIL WALL = 0.061 (1.65)	ES16070	0.287	0.428
	2.500 x 1.750 JAMB WALL = 0.056 (1.42)	ES16248	0.522	0.778
	2.500 x 1.731 INTERIOR SILL WALL = 0.062 (1.57)	ES16271	0.456	0.679
	1.901 x 0.531 HEAD TRIM WALL = 0.062 (1.57)	ES16364	0.206	0.306

NOTES:

MISCELLANEOUS WINDOW SHAPES

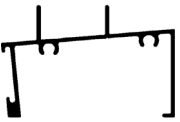
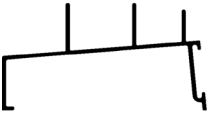
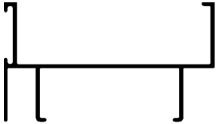
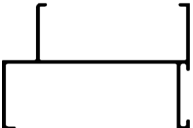
220

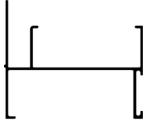
DRAWING	DESCRIPTION	DIE NUMBER	LBS/FT	KG/M
	2.500 x 1.750 INSIDE SILL WALL = 0.062 (1.57)	ES16737	0.548	0.815
	3.036 x 1.748 EXTERIOR SILL WALL = 0.063 (1.60)	ES16746	0.536	0.797
	2.937 x 1.811 HEADER WALL = 0.059 (1.50)	ES16771	0.537	0.799
	2.500 x 1.812 INTERIOR HEAD WALL = 0.050 (1.27)	ES17501	0.395	0.587
	2.500 x 1.750 FRAME JAMB WALL = 0.062 (1.57)	ES17744	0.594	0.884
	2.525 x 2.312 EXTERIOR HEAD WALL = 0.050 (1.27)	ES20272	0.475	0.707







NOTES:

CHAPTER 3

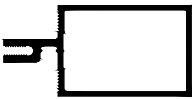
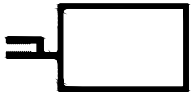
ARCHITECTURAL SHAPES





CURTAIN WALLS

300

DRAWING	DESCRIPTION	DIE NUMBER	LBS/FT	KG/M
	2.000 x 2.750 MULLION WALL = 0.093 (2.36)	EH09674	1.351	2.010
	2.000 x 2.770 MULLION WALL = 0.095 (2.41)	EH06672	1.358	2.020
	2.000 x 3.000 MULLION WALL = 0.093 (2.36)	EH05252	1.442	2.146
	2.000 x 3.000 MULLION WALL = 0.087 (2.21)	EH13166	1.366	2.032
	2.000 x 3.940 MULLION WALL = 0.085 (2.16)	EH06628	1.546	2.301
	2.000 x 4.000 MULLION WALL = 0.093 (2.36)	EH10657	1.625	2.419
	2.000 x 4.000 MULLION WALL = 0.093 (2.36)	EH11633	1.661	2.472
	2.000 x 4.000 MULLION WALL = 0.090 (2.29)	EH11955	1.613	2.400
NOTES:				

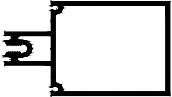
CURTAIN WALLS

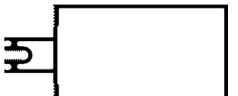
300

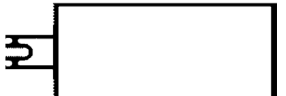
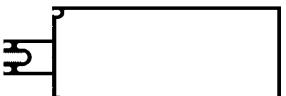
DRAWING	DESCRIPTION	DIE NUMBER	LBS/FT	KG/M
	2.000 x 5.000 MULLION WALL = 0.093 (2.36)	EH63581	2.064	3.071
	2.500 x 2.875 MULLION WALL = 0.093 (2.36)	EH11025	1.627	2.421
	2.500 x 3.625 MULLION WALL = 0.090 (2.29)	EH05223	1.741	2.591
	2.500 x 4.000 MULLION WALL = 0.093 (2.36)	EH05908	1.936	2.881
	2.500 x 4.000 MULLION WALL = 0.093 (2.36)	EH17655	1.855	2.761
	2.500 x 5.250 MULLION WALL = 0.093 (2.36)	EH61781	2.440	3.632
	2.500 x 5.250 MULLION WALL = 0.093 (2.36)	EH64098	2.310	3.438
	2.500 x 5.250 MULLION WALL = 0.090 (2.29)	EH21194	2.092	3.113
NOTES:				







CURTAIN WALLS

300

DRAWING	DESCRIPTION	DIE NUMBER	LBS/FT	KG/M
	<p>2.500 x 6.625 MULLION WALL = 0.100 (2.54)</p>	<p>EH64081</p>	<p>2.869</p>	<p>4.269</p>
<p>NOTES:</p>				

PRESSURE PLATES, CAPS AND SPIGOTS



310

DRAWING	DESCRIPTION	DIE NUMBER	LBS/FT	KG/M
	1.875 x 0.461 PRESSURE PLATE WALL = 0.080 (2.03)	ES10220	0.278	0.414
	2.375 x 0.461 PRESSURE PLATE WALL = 0.080 (2.03)	ES13851	0.326	0.485
	2.000 x 0.750 CAP WALL = 0.062 (1.57)	ES05285	0.295	0.440
	2.000 x 0.750 CAP WALL = 0.062 (1.57)	ES05924	0.264	0.393
	2.500 x 0.750 CAP WALL = 0.062 (1.57)	ES05197	0.331	0.493
	2.500 x 0.750 CAP WALL = 0.062 (1.57)	ES05923	0.300	0.446
	1.750 x 0.829 2" SPIGOT WALL = 0.125 (3.18)	ES13297	0.614	0.913

NOTES:





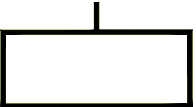
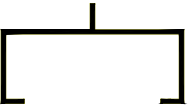
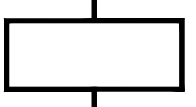
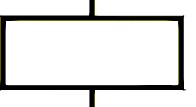
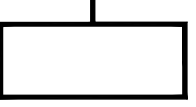
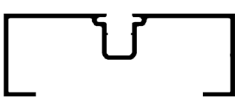

ENTRANCE WAYS

320

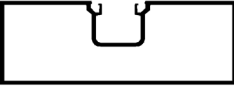
DRAWING	DESCRIPTION	DIE NUMBER	LBS/FT	KG/M
	4.000 x 1.750 RECT. B-TUBE WALL = 0.090 (2.29)	EH12077	1.183	1.761
	4.500 x 1.750 RECT. B-TUBE WALL = 0.090 (2.29)	EH13177	1.289	1.919
	4.000 x 1.750 x .625 FIN 4" SINGLE FIN TUBE WALL = 0.090 (2.29)	EH05187	1.249	1.859
	4.000 x 1.750 x .625 FIN 4" OPEN BACK SINGLE FIN TUBE WALL = 0.095 (2.41)	ES05188	0.980	1.459
	4.000 x 1.750 x .625 FIN 4" DOUBLE FIN TUBE WALL = 0.090 (2.29)	EH05189	1.316	1.958
	4.000 x 1.750 x .750 FIN 4" DOUBLE FIN TUBE WALL = 0.090 (2.29)	EH05255	1.343	1.999
	4.000 x 1.750 x .750 FIN 4" SINGLE FIN TUBE WALL = 0.083 (2.11)	EH05256	1.167	1.737
	4.500 x 1.750 4-1/2" OPEN BACK FLUSHLINE WALL = 0.090 (2.29)	ES05316	1.155	1.720
NOTES:				

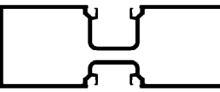

ENTRANCE WAYS

320

DRAWING	DESCRIPTION	DIE NUMBER	LBS/FT	KG/M
	4.500 x 1.750 4-1/2" CLOSED BACK FLUSHLINE WALL = 0.090 (2.29)	EH05317	1.527	2.273
	4.500 x 1.750 4-1/2" CLOSED BACK FLUSHLINE WALL = 0.085 (2.16)	EH17413	1.414	2.104
	4.500 x 1.750 4-1/2" DOUBLE SIDED FLUSHLINE WALL = 0.090 (2.29)	EH05318	1.644	2.446
	4.500 x 1.750 4-1/2" DOUBLE SIDED FLUSHLINE WALL = 0.085 (2.16)	EH17412	1.532	2.280
	0.500 x 0.500 CHANNEL (GLASS STOP) WALL = 0.062 (1.57)	ES13586	0.100	0.149
	0.625 x 0.500 CHANNEL (GLASS STOP) WALL = 0.062 (1.57)	ES05190	0.119	0.177
	0.750 X 0.500 CHANNEL (GLASS STOP) WALL = 0.060 (1.52)	ES05665	0.133	0.198
	0.700 x 0.700 GLASS STOP WALL = 0.062 (1.57)	ES12629	0.123	0.182
NOTES:				

ENTRANCE WAYS





320

DRAWING	DESCRIPTION	DIE NUMBER	LBS/FT	KG/M
	<p>0.840 x 0.750 SNAP-ON COVER WALL VARIES</p>	<p>ES12630</p>	<p>0.093</p>	<p>0.139</p>
	<p>0.986 x 0.970 BLADE STOP WALL VARIES</p>	<p>ES18137</p>	<p>0.208</p>	<p>0.310</p>

NOTES:

COMMERCIAL DOORS

340

DRAWING	DESCRIPTION	DIE NUMBER	LBS/FT	KG/M
	<p>3.898 x 0.500 THRESHOLD WALL = 0.070 (1.78)</p>	<p>ES11805</p>	<p>0.522</p>	<p>0.776</p>
	<p>4.000 x 0.500 4" THRESHOLD WALL = 0.218 (5.54)</p>	<p>ES05460</p>	<p>0.876</p>	<p>1.303</p>
	<p>0.560 x 0.665 SINGLE GLAZE STOP WALL = 0.050 (1.27)</p>	<p>ES10109</p>	<p>0.132</p>	<p>0.196</p>
	<p>0.850 x 0.688 DOOR STOP WALL VARIES</p>	<p>ES12974</p>	<p>0.187</p>	<p>0.278</p>









NOTES:

CHAPTER 4

MISCELLANEOUS SHAPES







SIGN SHAPES

400

DRAWING	DESCRIPTION	DIE NUMBER	LBS/FT	KG/M
	6.000 x 0.984 EX 1 (w/ GROOVES) WALL = 0.078 (1.98)	ES05100	0.858	1.277
	6.000 x 0.984 EX 1 (PLAIN) WALL = 0.078 (1.98)	ES10453	0.863	1.284
	7.500 x 0.750 EX 2 WALL = 0.090 (2.29)	ES05104	0.937	1.394
	1.000 x 1.000 EX 3 WALL = 0.062 (1.58)	ES05102	0.142	0.211
	2.000 x 1.000 EX 4 WALL = 0.095 (2.41)	ES05196	0.326	0.485
	1.000 x 1.500 EX 5 WALL = 0.090 (2.29)	ES05099	0.353	0.525
	1.250 x 1.250 EX 6 WALL = 0.093 (2.36)	ES05101	0.264	0.393
	2.176 x 1.478 EX 7 LIGHT WALL = 0.083 (2.11)	EH05428	0.552	0.821
NOTES:				



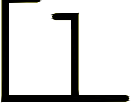

SIGN SHAPES

400

DRAWING	DESCRIPTION	DIE NUMBER	LBS/FT	KG/M
	<p>8.125 x 1.000 EX 8 WALL = 0.078 (1.98)</p>	<p>ES61779</p>	<p>1.053</p>	<p>1.567</p>
	<p>1.375 x 1.000 EX 9 WALL = 0.090 (2.29)</p>	<p>ES05835</p>	<p>0.346</p>	<p>0.515</p>
	<p>1.625 x 1.200 EX 11 WALL = 0.080 (2.03)</p>	<p>ES05088</p>	<p>0.432</p>	<p>0.643</p>
	<p>1.858 x 0.966 EX 12 LIGHT WALL = 0.083 (2.11)</p>	<p>EH05427</p>	<p>0.406</p>	<p>0.604</p>
	<p>2.500 x 2.250 EX 13 WALL = 0.125 (3.18)</p>	<p>EH05281</p>	<p>1.082</p>	<p>1.610</p>
	<p>4.000 x 0.870 EX 14 WALL = 0.080 (2.03)</p>	<p>ES05836</p>	<p>0.643</p>	<p>0.957</p>
<p>NOTES:</p>				

STREET SIGNS

410

DRAWING	DESCRIPTION	DIE NUMBER	LBS/FT	KG/M
	<p>1.750 x 1.875 SIGN BRACKET WALL = 0.188 (4.78)</p>	<p>ES11255</p>	<p>1.112</p>	<p>1.655</p>
	<p>6.250 x 0.250 SIGN BLADE WALL = 0.090 (2.29)</p>	<p>ES11256</p>	<p>0.975</p>	<p>1.450</p>
	<p>8.000 x 0.250 SIGN BLADE WALL = 0.115 (2.91)</p>	<p>ES12405</p>	<p>1.340</p>	<p>1.994</p>
	<p>9.000 x 0.250 SIGN BLADE WALL = 0.125 (3.17)</p>	<p>ES62342</p>	<p>1.591</p>	<p>2.368</p>

NOTES:

CABLE TRAY AND POWER ACCESSORIES



500

DRAWING	DESCRIPTION	DIE NUMBER	LBS/FT	KG/M
	<p>1.625 x 1.625 RUNG WALL = 0.110 (2.79)</p>	<p>ES08300</p>	<p>0.716</p>	<p>1.065</p>

NOTES:

GREENHOUSE SHAPES

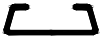

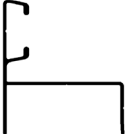
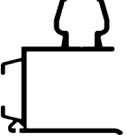
700

DRAWING	DESCRIPTION	DIE NUMBER	LBS/FT	KG/M
	<p>1.250 x 0.433 WIRELOCK WALL = 0.062 (1.57)</p>	<p>ES12233</p>	<p>0.177</p>	<p>0.263</p>
	<p>1.157 x 1.001 CAMLOCK BASE WALL = 0.094 (2.39)</p>	<p>ES63475</p>	<p>0.390</p>	<p>0.581</p>
	<p>2.435 x 1.086 DRIP GUTTER WALL = 0.065 (1.65)</p>	<p>ES63478</p>	<p>0.236</p>	<p>0.352</p>
	<p>2.565 x 2.141 BASE PANEL SMALL "H" WALL = 0.067 (1.69)</p>	<p>ES63480</p>	<p>0.521</p>	<p>0.776</p>
	<p>2.618 x 2.198 VENT SILL WALL = 0.094 (2.39)</p>	<p>ES64072</p>	<p>0.931</p>	<p>1.385</p>

NOTES:



HOUSEBOAT SHAPES

800

DRAWING	DESCRIPTION	DIE NUMBER	LBS/FT	KG/M
	<p>2.812 x 1.500 BOAT TRIM WALL = 0.125 (3.18)</p>	<p>ES11112</p>	<p>0.537</p>	<p>0.800</p>
	<p>4.000 x 1.720 WEB CHANNEL WALL = 0.250 (6.35)</p>	<p>ES60046</p>	<p>2.247</p>	<p>3.343</p>
	<p>4.976 x 1.004 DECK SECTION WALL VARIES</p>	<p>ES60716</p>	<p>0.734</p>	<p>1.093</p>
<p>NOTES:</p>				

SCHOOL PRODUCTS



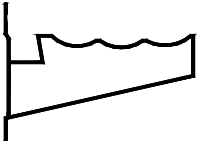



900

DRAWING	DESCRIPTION	DIE NUMBER	LBS/FT	KG/M
	<p>3.240 x 1.500 CHALK TRAY WALL = 0.070 (1.78)</p>	<p>ES11744</p>	<p>0.514</p>	<p>0.764</p>
	<p>2.100 x 0.829 CHALK TRAY WALL VARIES</p>	<p>ES11748</p>	<p>0.351</p>	<p>0.523</p>
	<p>4.100 x 3.250 CHALK TRAY WALL = 0.064 (1.63)</p>	<p>EH12653</p>	<p>0.990</p>	<p>1.473</p>

NOTES:





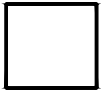



R.V. SHAPES

1000

DRAWING	DESCRIPTION	DIE NUMBER	LBS/FT	KG/M
	0.750 x 0.750 SQUARE TUBE WALL = 0.062 (1.57)	EH09986	0.196	0.292
	0.750 x 0.750 SQUARE TUBE WALL = 0.120 (3.05)	EH11066	0.363	0.540
	0.938 x 0.938 SQUARE TUBE WALL = 0.040 (1.02)	EH60445	0.161	0.240
	1.000 x 1.000 SQUARE TUBE WALL = 0.040 (1.02)	EH60714	0.173	0.258
	1.000 x 1.000 SQUARE TUBE WALL = 0.060 (1.52)	EH09509	0.259	0.385
	1.438 x 0.938 RECT. TUBE WALL = 0.040 (1.02)	EH60593	0.212	0.315
	1.500 x 0.750 RECT. TUBE WALL = 0.040 (1.02)	EH60479	0.200	0.297
	1.500 x 1.500 SQUARE TUBE WALL = 0.040 (1.02)	EH60756	0.280	0.416
NOTES:				

R.V. SHAPES







1000

DRAWING	DESCRIPTION	DIE NUMBER	LBS/FT	KG/M
	1.500 x 1.500 SQUARE TUBE WALL = 0.045 (1.14)	EH60447	0.305	0.454
	1.500 x 1.500 SQUARE TUBE WALL = 0.060 (1.52)	EH09794	0.399	0.594
	1.500 x 1.500 SQUARE TUBE WALL = 0.125 (3.18)	EH09741	0.795	1.183
	1.938 x 0.938 RECT. TUBE WALL = 0.040 (1.02)	EH60596	0.260	0.387
	2.000 x 2.000 SQUARE TUBE WALL = 0.120 (3.05)	EH11064	1.083	1.612
	2.500 x 1.500 RECT. TUBE WALL = 0.058 (1.47)	EH60470	0.535	0.796
	3.000 x 0.750 RECT. TUBE WALL = 0.125 (3.18)	EH11585	1.050	1.563
	3.000 x 2.000 RECT. TUBE WALL = 0.090 (2.29)	EH61706	1.079	1.605

NOTES:



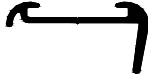



R.V. SHAPES

1000

DRAWING	DESCRIPTION	DIE NUMBER	LBS/FT	KG/M
	<p>6.000 x 3.000 SCALLOPED TUBE WALL = 0.260 (6.60)</p>	<p>EH61771</p>	<p>5.065</p>	<p>7.537</p>
	<p>1.000 x 1.000 ANGLE WALL = 0.053 (1.35)</p>	<p>ES11185</p>	<p>0.124</p>	<p>0.184</p>
	<p>2.000 x 1.125 H-CHANNEL WALL VARIES</p>	<p>ES09040</p>	<p>0.241</p>	<p>0.358</p>
	<p>5.125 x 0.365 BOTTOM RAIL WALL VARIES</p>	<p>ES60450</p>	<p>0.882</p>	<p>1.312</p>
	<p>2.500 x 1.875 CHANNEL WALL = 0.055 (1.40)</p>	<p>ES60526</p>	<p>0.526</p>	<p>0.783</p>
	<p>1.160 x 0.625 ROOF EDGE WALL = 0.045 (1.14)</p>	<p>ES60595</p>	<p>0.137</p>	<p>0.204</p>
	<p>2.910 x 1.580 F-CHANNEL WALL = 0.100 (2.54)</p>	<p>ES60743</p>	<p>0.662</p>	<p>0.985</p>
<p>NOTES:</p>				



DOCK SHAPES

1200

DRAWING	DESCRIPTION	DIE NUMBER	LBS/FT	KG/M
	<p>4.000 x 1.890 DOCK STRINGER WALL VARIES</p>	<p>ES09650</p>	<p>1.172</p>	<p>1.744</p>
	<p>5.970 x 1.075 DOCK TREAD WALL = 0.070 (1.78)</p>	<p>ES09830</p>	<p>0.904</p>	<p>1.345</p>
	<p>5.970 x 1.070 DOCK TREAD WALL = 0.060 (1.52)</p>	<p>ES10531</p>	<p>0.778</p>	<p>1.157</p>
	<p>2.335 x 2.335 SQ. TUBE WALL = 0.140 (3.56)</p>	<p>EH10802</p>	<p>1.414</p>	<p>2.105</p>
	<p>4.500 x 0.828 DOCK LEG CLAMP WALL = 0.328 (8.33)</p>	<p>ES11218</p>	<p>1.900</p>	<p>2.828</p>
	<p>4.102 x 1.530 SIDE RAIL BOX WALL = 0.125 (3.18)</p>	<p>EH61646</p>	<p>1.638</p>	<p>2.438</p>
<p>NOTES:</p>				

RAMP SHAPES



1300

DRAWING	DESCRIPTION	DIE NUMBER	LBS/FT	KG/M
	<p>1.937 x 0.750 HINGE WALL VARIES</p>	<p>ES09545</p>	<p>0.693</p>	<p>1.031</p>
	<p>6.532 x 1.077 WALK RAMP TREAD WALL = 0.075 (1.91)</p>	<p>ES10324</p>	<p>1.220</p>	<p>1.816</p>

NOTES:

FENCING AND RAILING SHAPES

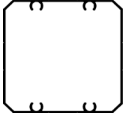



1400

DRAWING	DESCRIPTION	DIE NUMBER	LBS/FT	KG/M
	<p>2.965 x 2.965 POST WALL = 0.061 (1.55)</p>	<p>EH20573</p>	<p>0.938</p>	<p>1.395</p>
	<p>0.750 x 0.750 PICKET WALL = 0.050 (1.27)</p>	<p>EH20574</p>	<p>0.164</p>	<p>0.245</p>

NOTES:

MISCELLANEOUS

1500

DRAWING	DESCRIPTION	DIE NUMBER	LBS/FT	KG/M
	<p>2.475 x 0.130 BEVELLED FLAT BAR WALL VARIES</p>	<p>ES11899</p>	<p>0.292</p>	<p>0.434</p>
	<p>3.303 x 0.776 C-CHANNEL WALL VARIES</p>	<p>ES22251</p>	<p>1.119</p>	<p>1.665</p>
	<p>3.981 x 0.953 P-TUBE WALL VARIES</p>	<p>EH60601</p>	<p>0.506</p>	<p>0.753</p>
	<p>1.575 x 1.575 MODULAR TUBING WALL VARIES</p>	<p>EH60673</p>	<p>1.229</p>	<p>1.829</p>
	<p>8.625 x 0.750 CATHODE PLATE WALL VARIES</p>	<p>ES63350</p>	<p>5.788</p>	<p>8.614</p>

NOTES:

SECTION 2

ASSEMBLY DRAWINGS

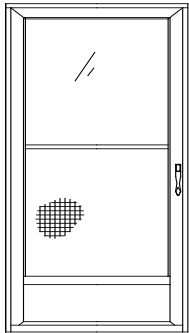
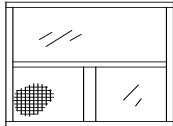

***1-3/4" STORM DOOR
GP2 WINDOW
2" CURTAIN WALL
2-1/2" CURTAIN WALL
4-1/2" x 1-3/4" FLUSHLINE
4" B-TUBE w/ 1/2" FIN
COMMERCIAL DOOR***

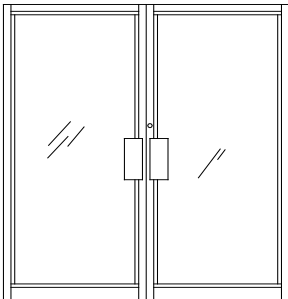
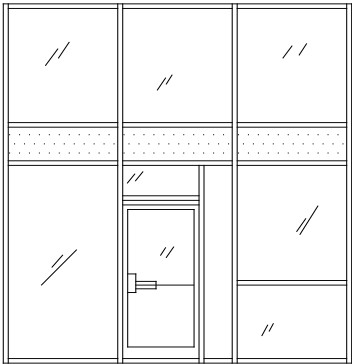

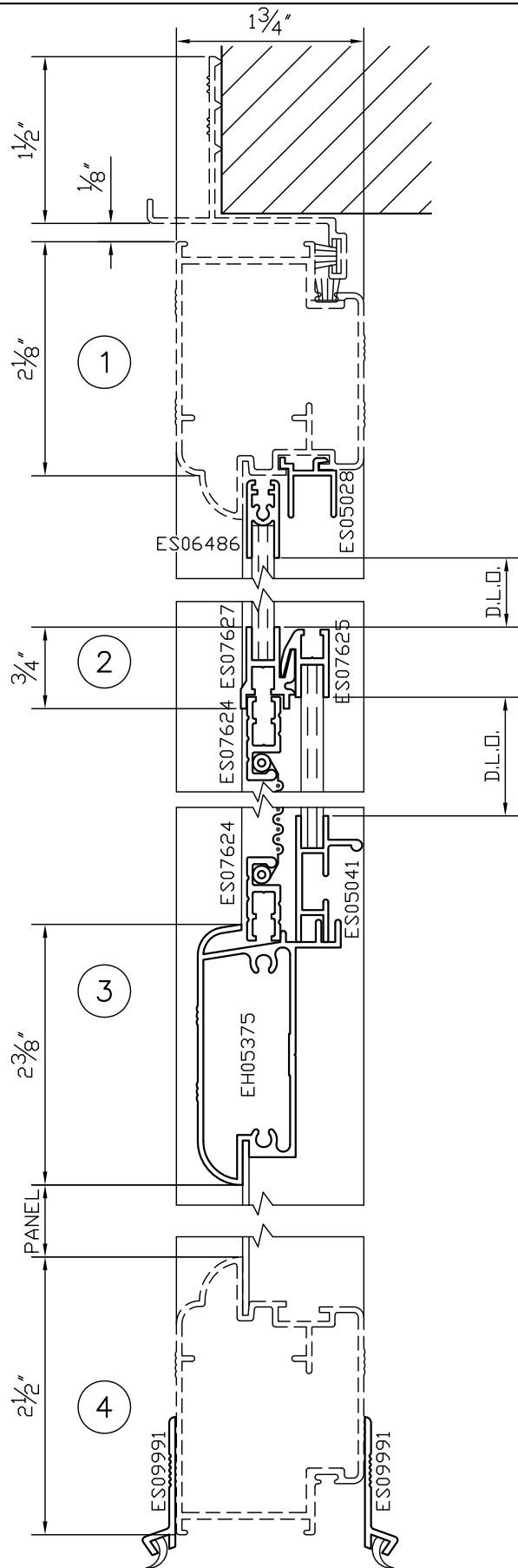

OUTSIDE

INSIDE

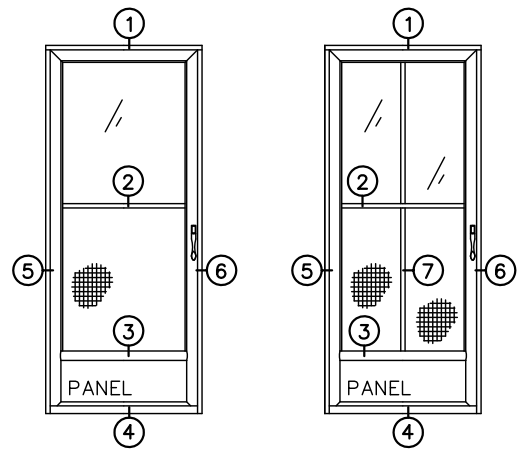
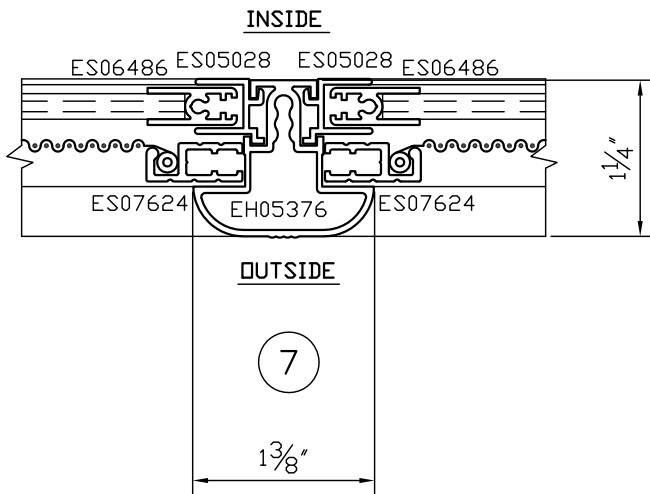
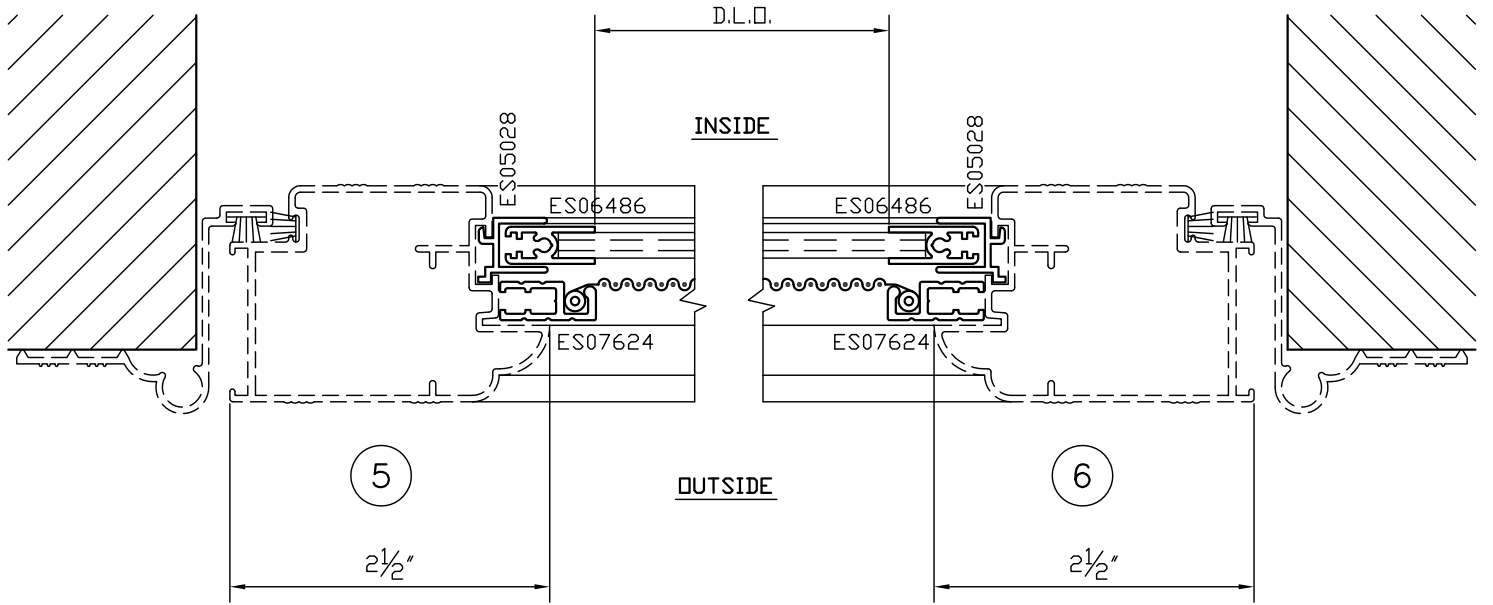

ITEM	DESCRIPTION	DIE NO.
a	GLASS STOP RUBBER SPLINE	N/A
b	PVC THERMAL BREAK	N/A
c	BUTYL TAPE	N/A
e	SCHLEGEL	N/A
f	RUBBER SPLINE	N/A
g	RIVET	N/A
h	SCREEN SPLINE	N/A
i	SCREEN MESH	N/A
j	SINGLE GLAZED SETTING BLOCK	N/A
k	RUBBER SPLINE	N/A
l	3mm GLASS	N/A
n	1" SEALED UNIT	N/A
o	SEALED UNIT SETTING BLOCK	N/A
p	ROLLER	N/A
q	PVC THERMAL BREAK	N/A

SCALE: N.T.S.	210-A02
REVISED: 11/03/06	

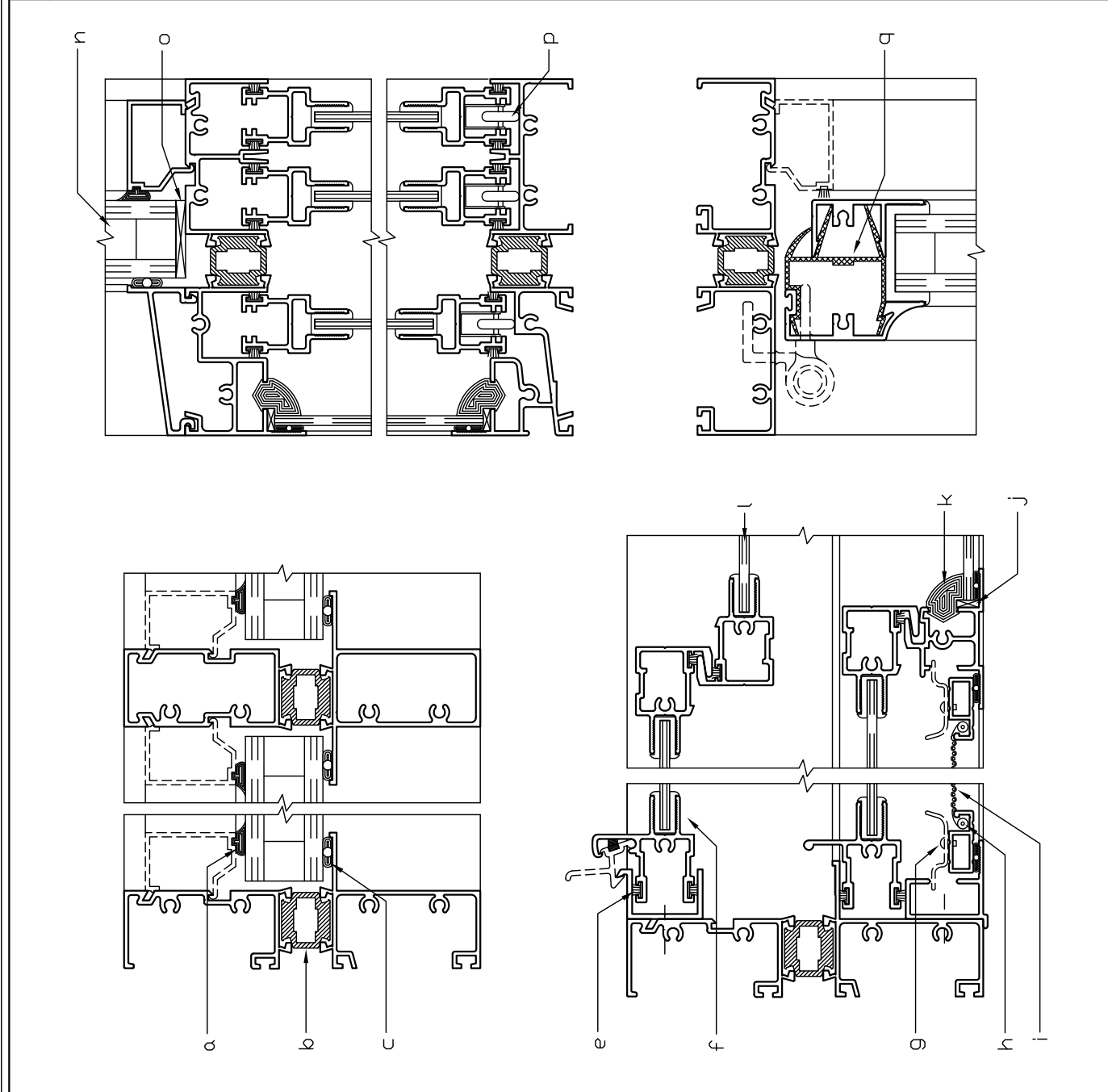

**GP2 WINDOW ASSEMBLY
NON-ALUMINUM PARTS LIST**

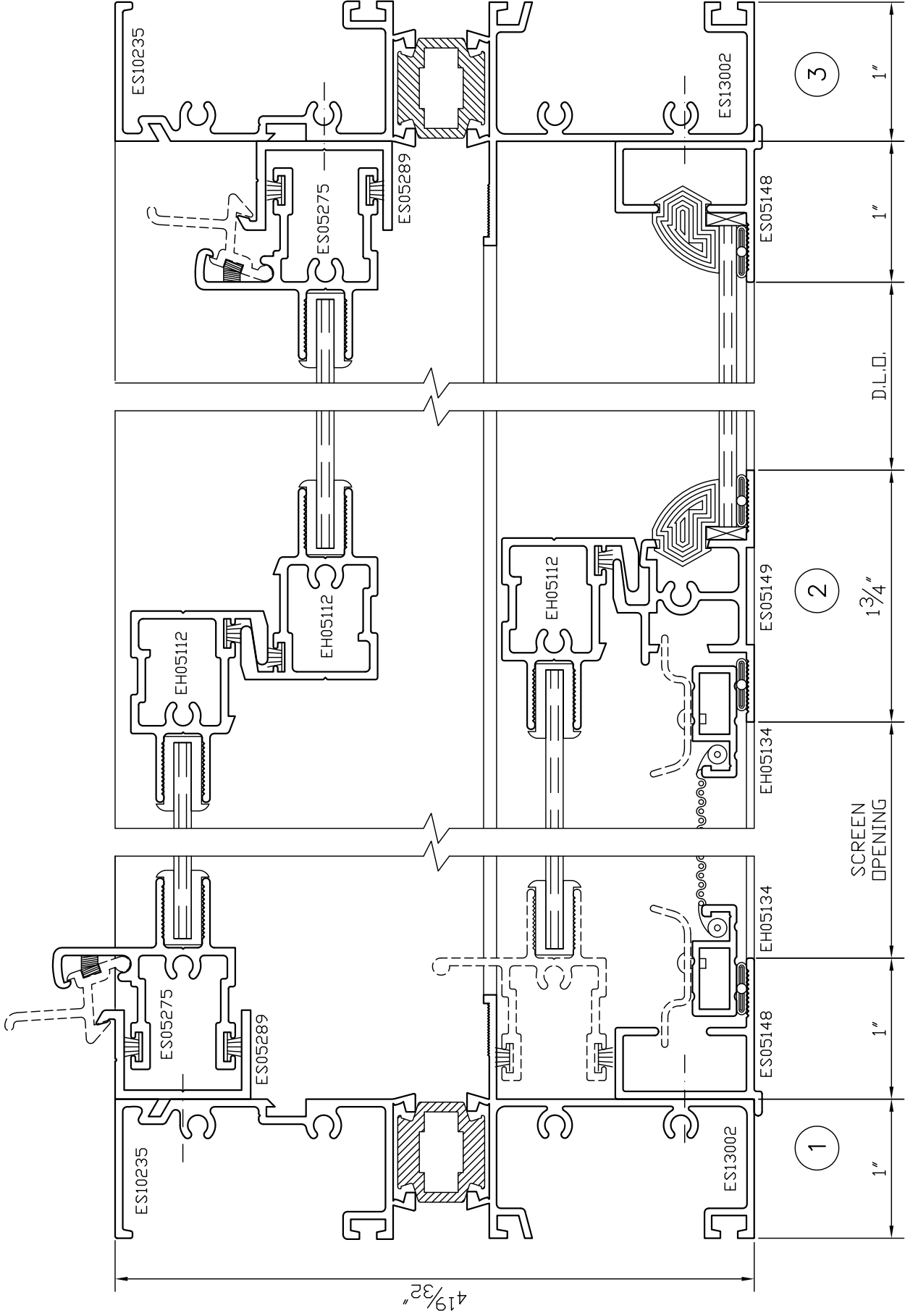

**GP2 WINDOW ASSEMBLY
DETAILS**

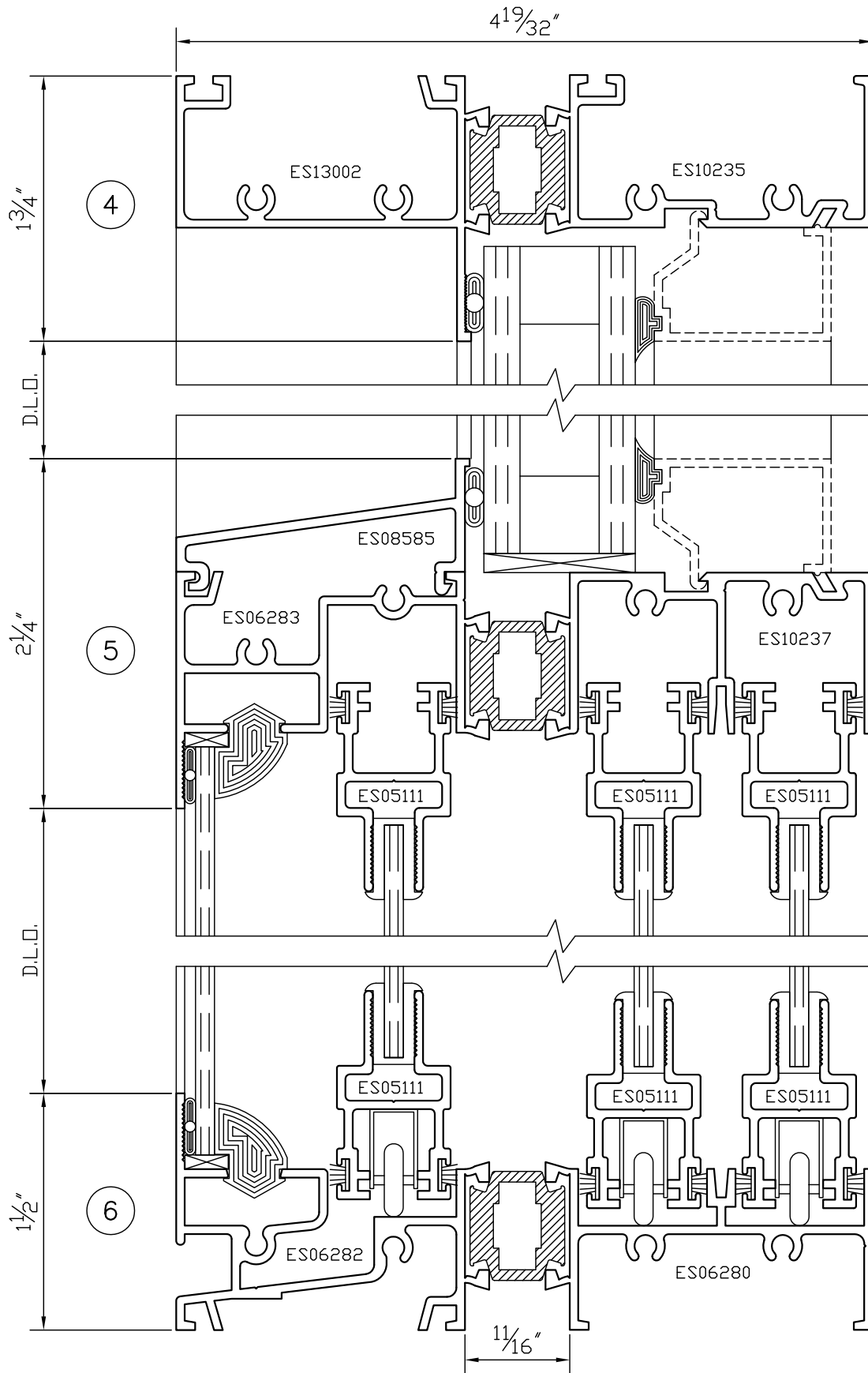

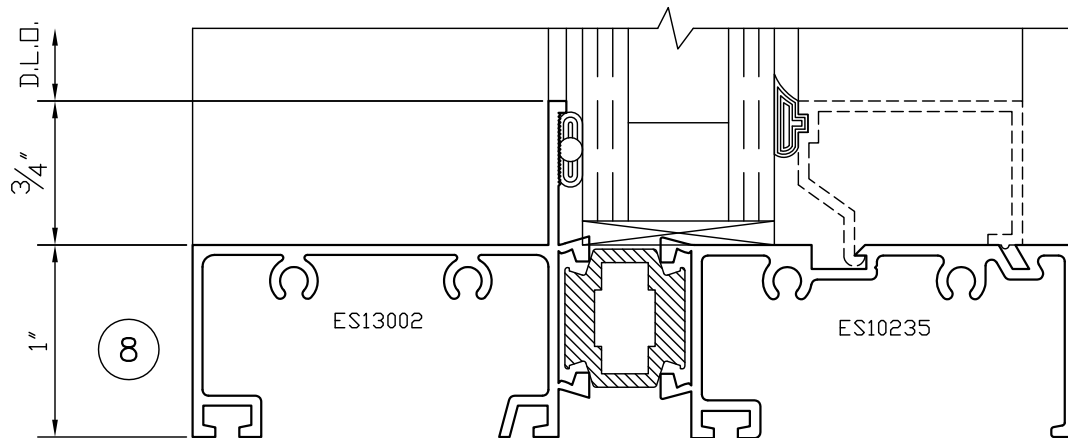
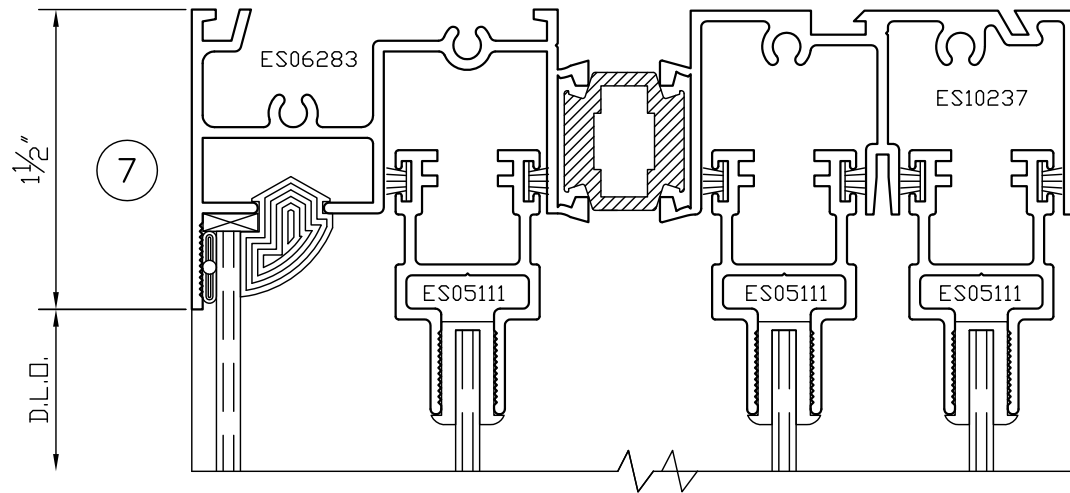
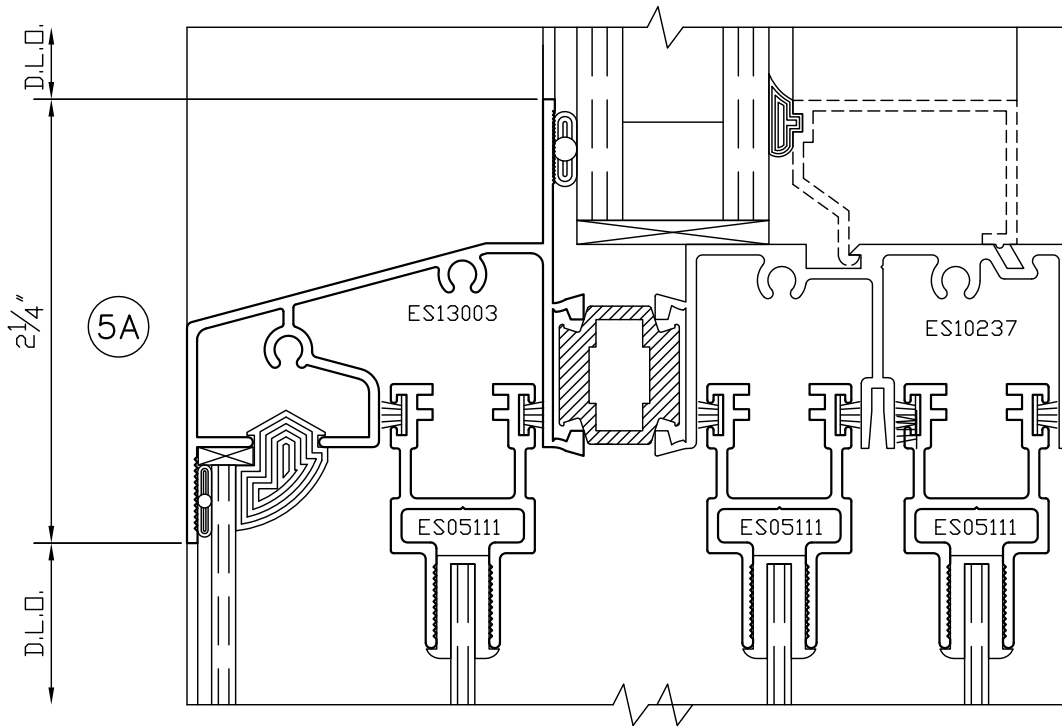

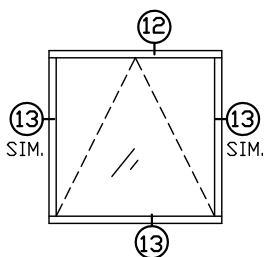
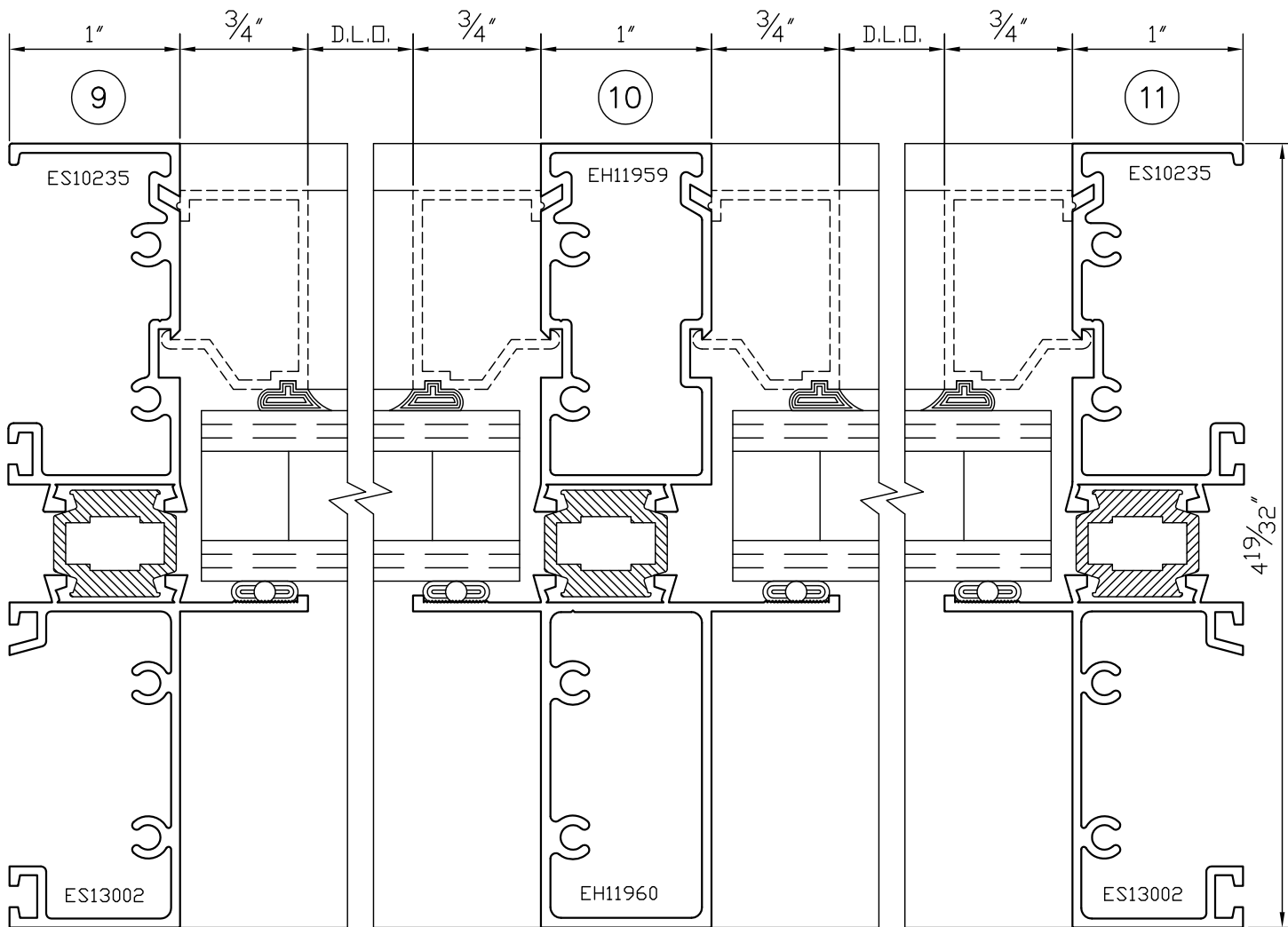

OPEN OUT WINDOW

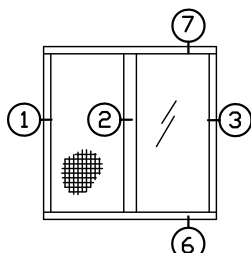

TYPICAL SLIDING WINDOW

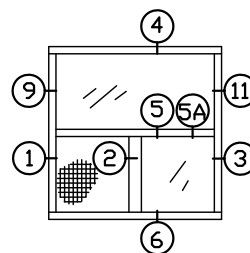

TYPICAL SLIDING & FIXED WINDOW

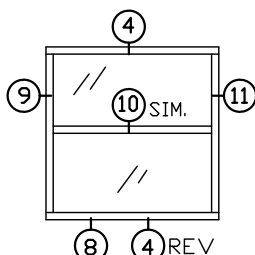

TYPICAL HORIZONTALLY FIXED WINDOW

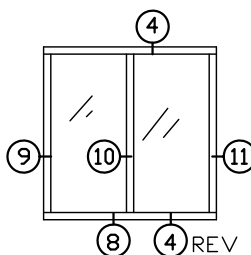

TYPICAL VERTICALLY FIXED WINDOW

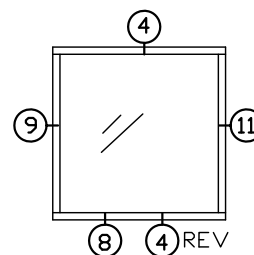

TYPICAL FIXED WINDOW

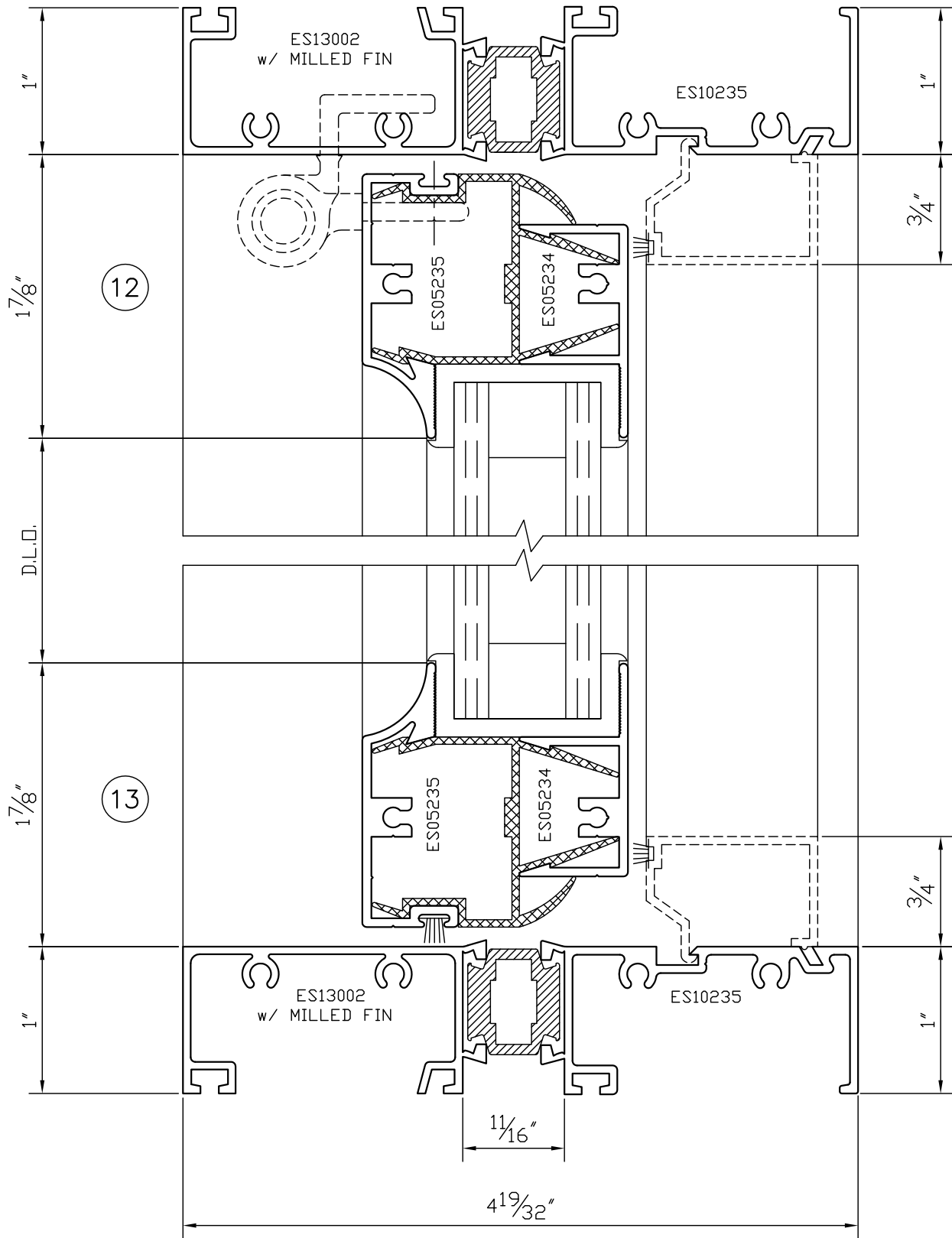

ITEM	DESCRIPTION	DIE NO.
A	2' x 3' MULLION	EH05252
B	2' x 3/4' CAP	ES05285
C	1-7/8" PRESSURE PLATE	ES05286
D	1-1/8" x 3/4" RECTANGULAR FILLER TUBE	XXXXXXXX
E	SINGLE GLAZING ADAPTOR	XXXXXXXX
F	2' x 1-3/4" BEVELLED STILE	EH06898
G	SINGLE GLAZED GLASS STOP	ES10109
H	CURTAIN WALL DOOR ADAPTOR	ES12377
I	DOOR STOP	ES12974
J	2-3/8" x 1-3/4" TOP RAIL	EH06896
K	4-1/8" x 1-3/4" TOP/BOTTOM RAIL	EH06897
L	4' x 1/2" THRESHOLD	ES05460
M	SEALED UNIT GLASS STOP	XXXXXXXX
N	DOOR SWEEP	XXXXXXXX
O	DOOR SWEEP COVER ADAPTOR	XXXXXXXX
P	2' SPIGOT	ES12378
a	#8 SCREW	N/A
b	PVC THERMAL BREAK	N/A
c	RUBBER GLAZING SPLINE	N/A
d	SCHLEGEL	N/A
e	BUTYL TAPE	N/A
f	DOOR RUBBER GLAZING SPLINE	N/A
g	1" SEALED UNIT	N/A
h	3mm GLASS	N/A
i	SINGLE GLAZED SETTING BLOCK	N/A
J	SEALED UNIT SETTING BLOCK	N/A
K	BACK PAN w/ BATT INSULATION	N/A
OPTIONAL DIES:		
A ₁	2' x 3' MULLION	EH13166
A _e	2' x 4' MULLION	EH11955
A _s	2' x 4' MULLION	EH11633
H ₁	CURTAIN WALL DOOR ADAPTOR	ES12855
P ₁	2' SPIGOT	ES12194
P ₂	2' SPIGOT	ES13297

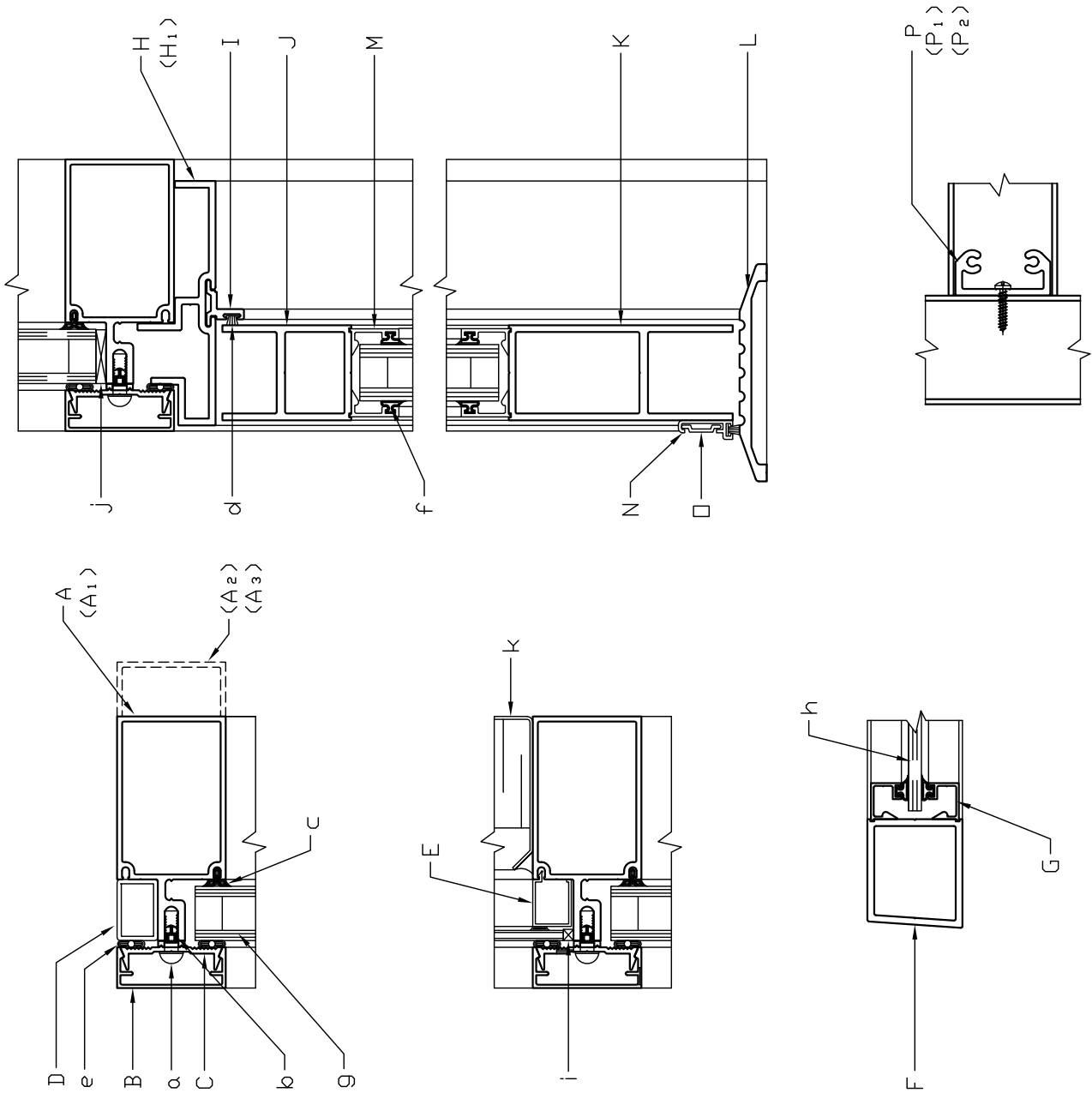

CAN ART
ALUMINUM EXTRUSION L.P.

**2" CURTAIN WALL ASSEMBLY
PARTS LIST**

SCALE: N.T.S.
REVISED: 11/03/06

300-A0

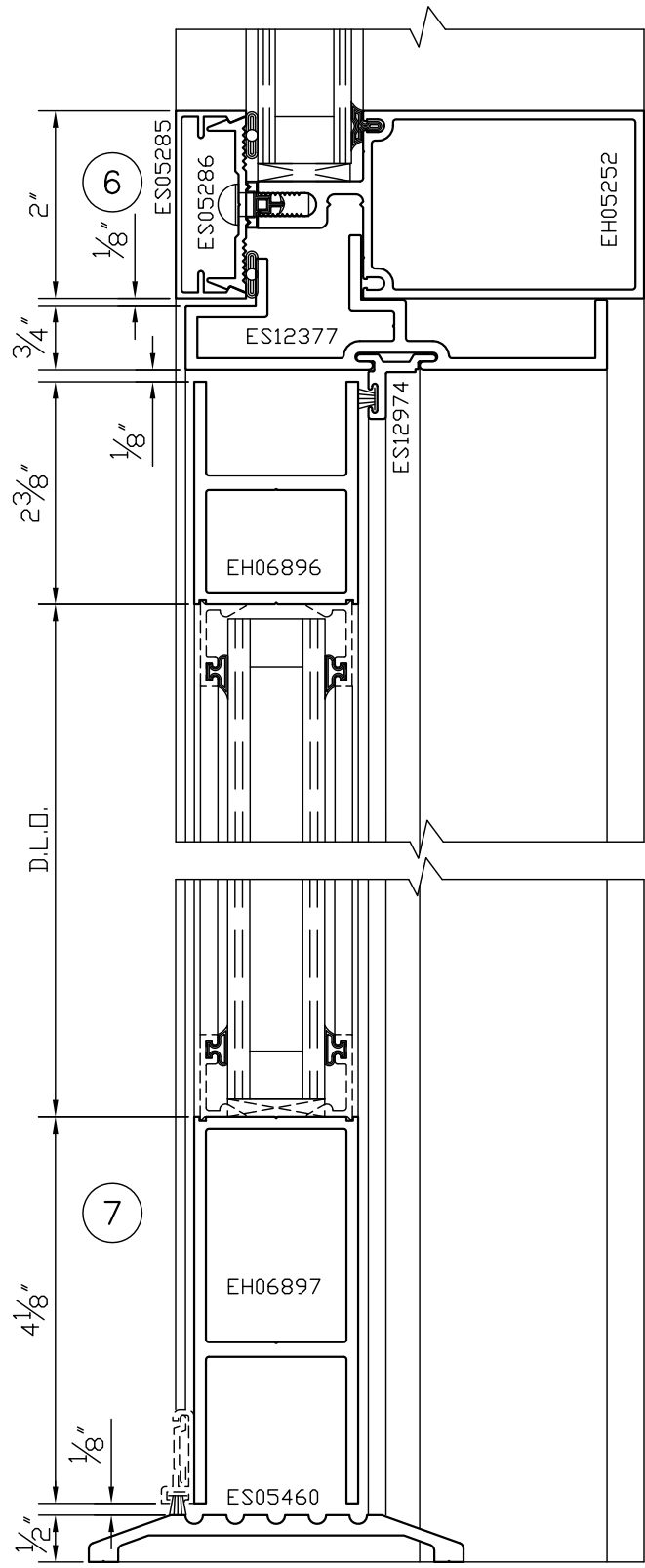
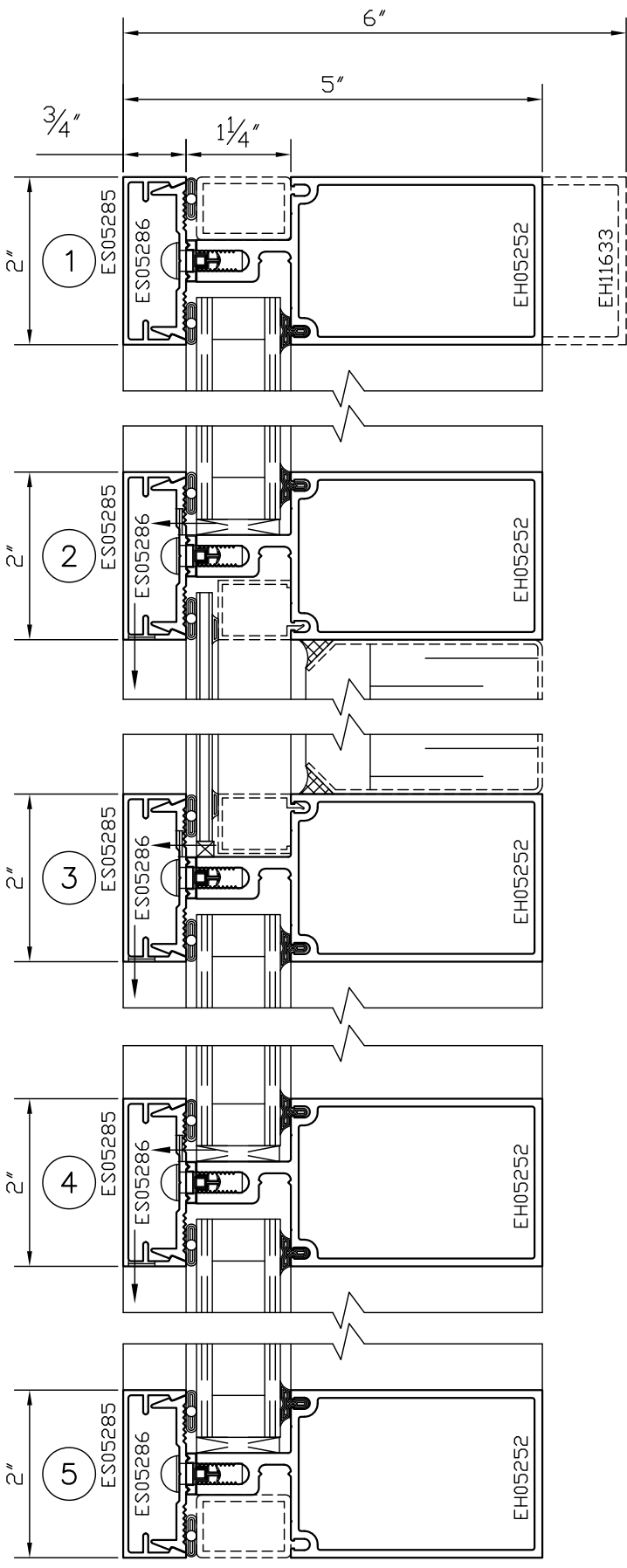

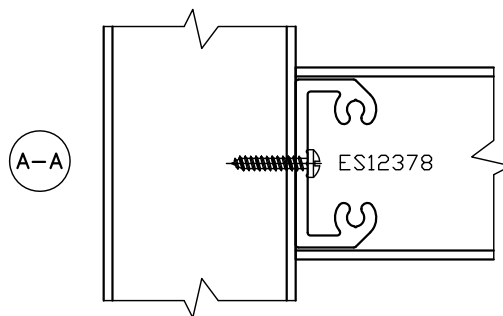
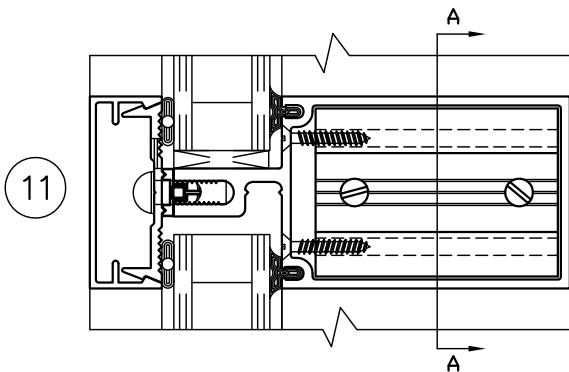
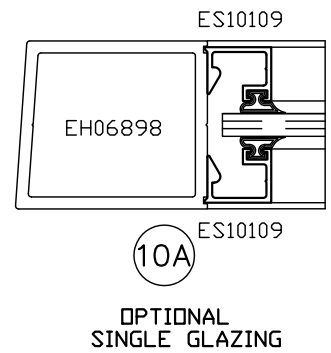
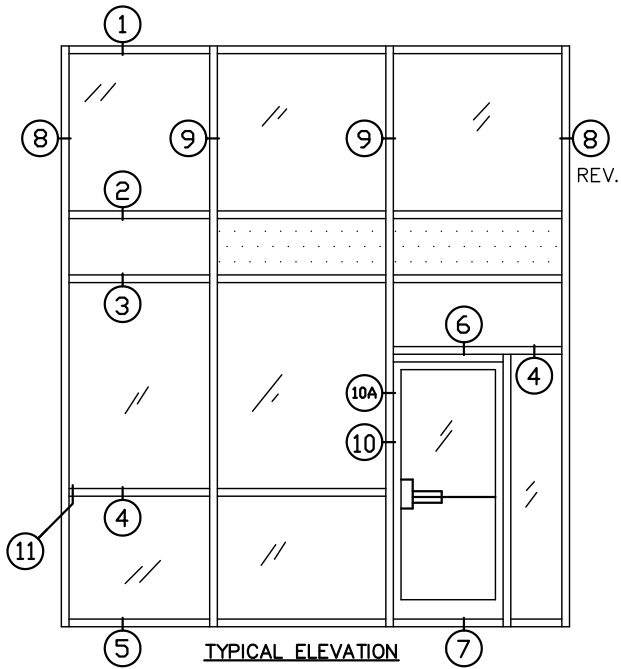
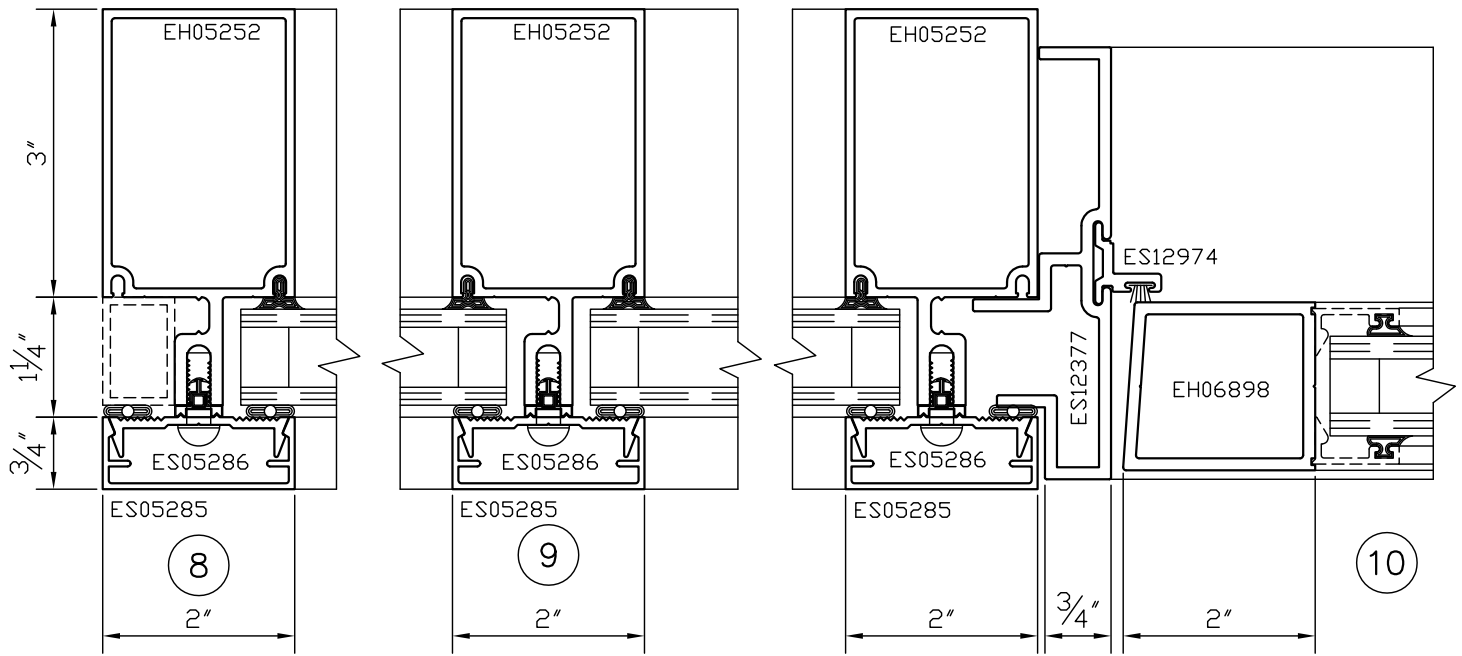

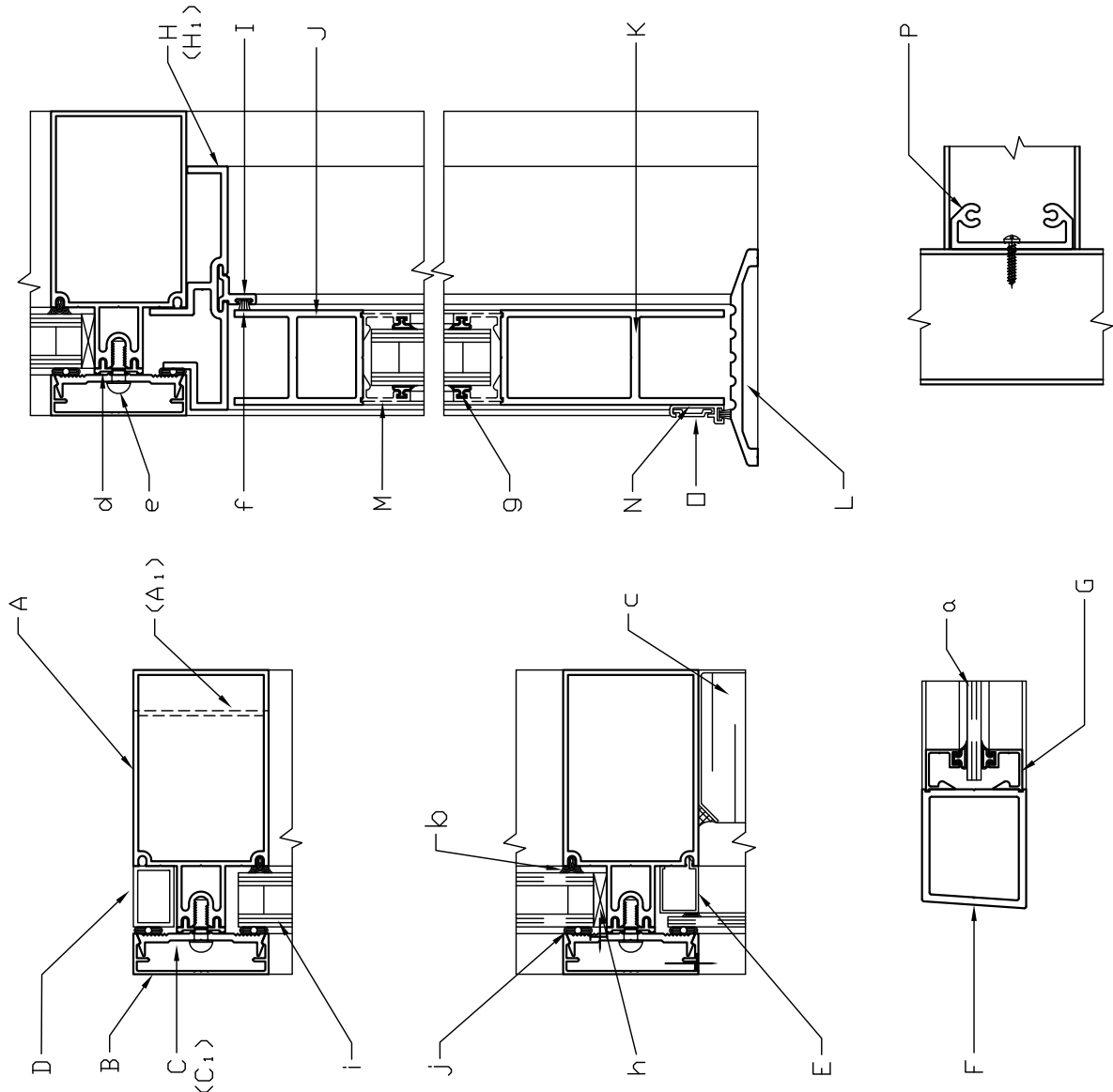

ITEM	DESCRIPTION	DIE NO.
A	2-1/2" x 3-5/8" MULLION	EH05223
B	3/4" x 2-1/2" CAP	ES05197
C	2-1/2" PRESSURE PLATE	ES05198
D	1-1/8" x 3/4" RECTANGULAR FILLER TUBE	XXXXXXXXX
E	SINGLE GLAZING ADAPTOR	XXXXXXXXX
F	2" x 1-3/4" BEVELLED STILE	EH06898
G	SINGLE GLAZED DOOR GLASS STOP	ES10109
H	CURTAIN WALL DOOR ADAPTOR	ES12377
I	DOOR STOP	ES12974
J	2-3/8" x 1-3/4" TOP RAIL	EH06896
K	4-1/8" x 1-3/4" TOP/BOTTOM RAIL	EH06897
L	4" x 1/2" THRESHOLD	ES05460
M	SEALED UNIT DOOR GLASS STOP	XXXXXXXXX
N	DOOR SWEEP	XXXXXXXXX
O	DOOR SWEEP COVER ADAPTOR	XXXXXXXXX
P	2-1/2" SPIGOT	ES05204
a	3mm GLASS	N/A
b	RUBBER GLAZING SPLINE	N/A
c	BACK PAN w/ BATT INSULATION	N/A
d	PVC THERMAL BREAK	N/A
e	#8 SCREW	N/A
f	SCHLEGEL	N/A
g	DOOR RUBBER GLAZING SPLINE	N/A
h	SEALED UNIT SETTING BLOCK	N/A
i	1" SEALED UNIT	N/A
j	BUTYL TAPE	N/A
OPTIMAL DIES:		
A1	2-1/2" x 2-7/8" MULLION	EH11025
C1	2-1/2" PRESSURE PLATE	ES13851
H1	CURTAIN WALL DOOR ADAPTOR	ES12855

2-1/2" CURTAIN WALL ASSEMBLY PARTS LIST

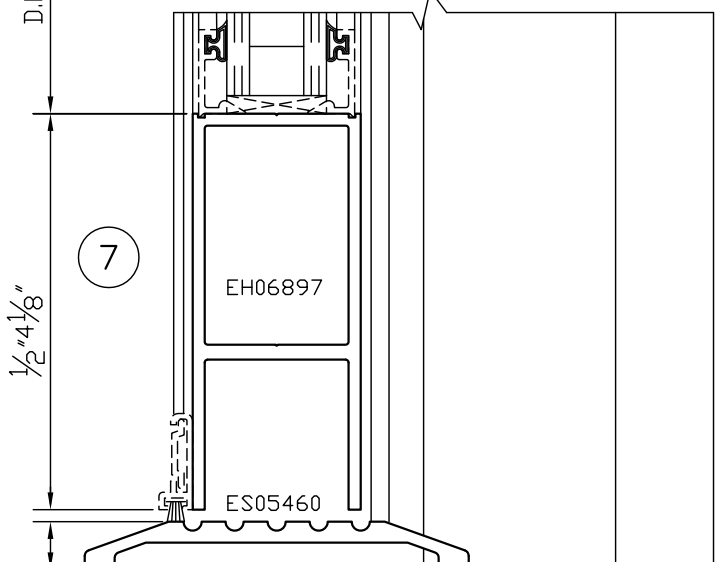
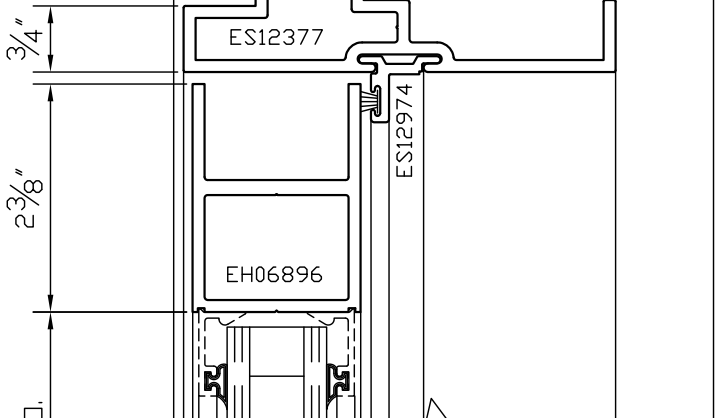
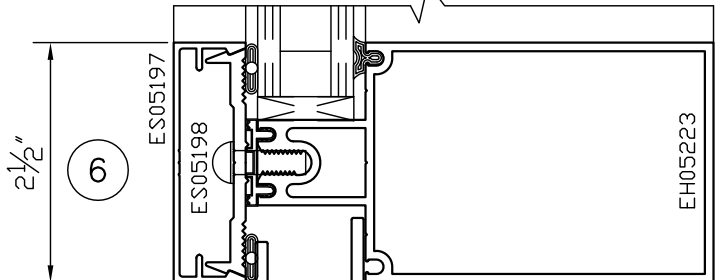
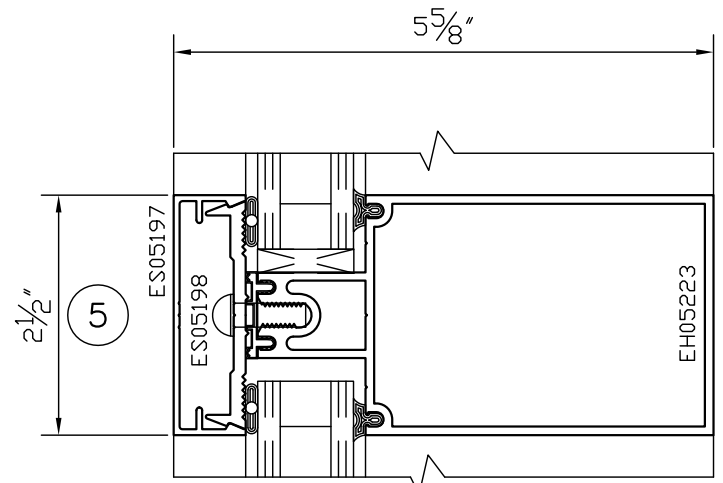
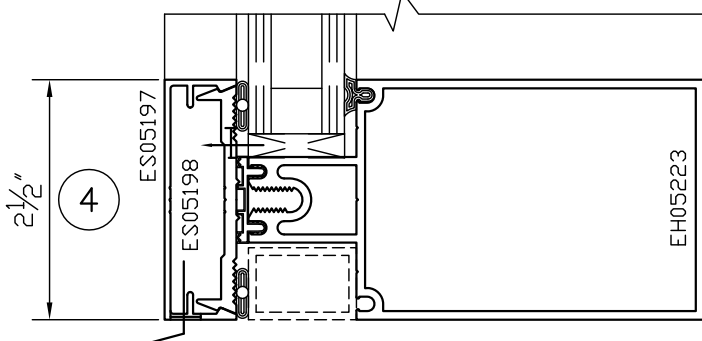
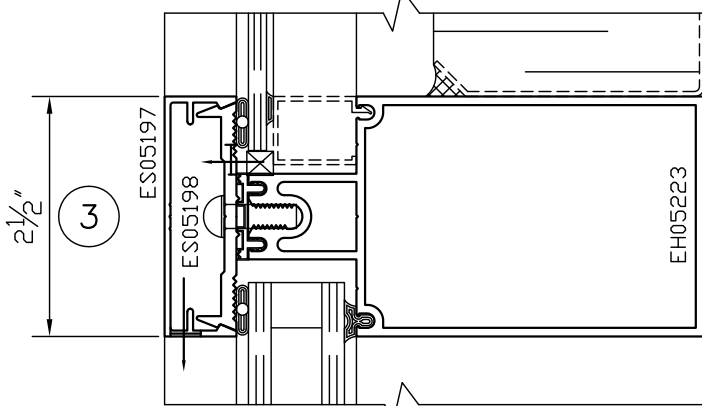
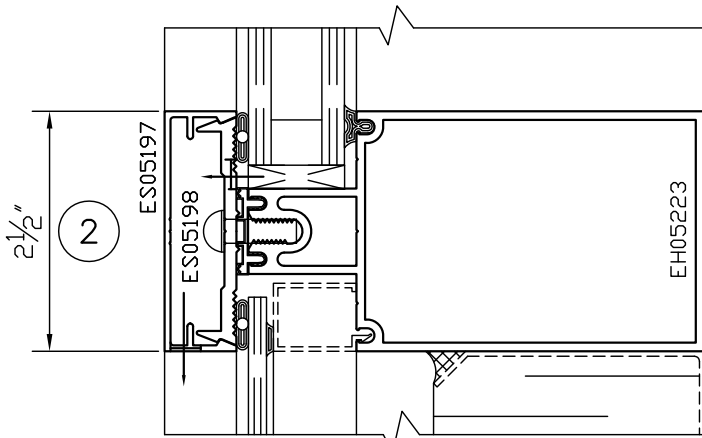
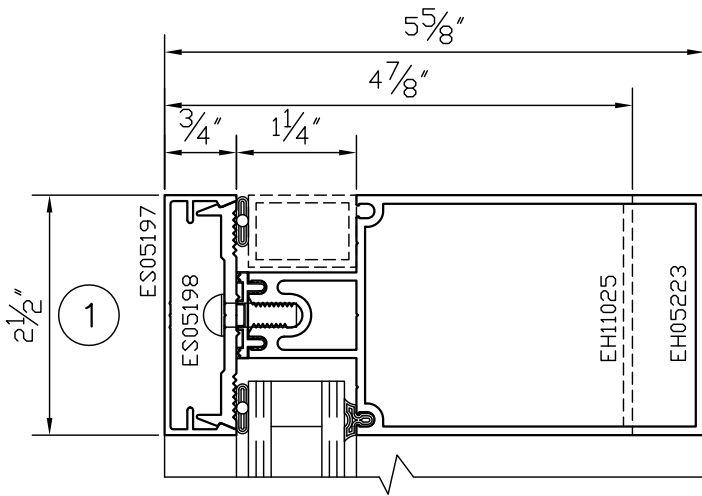

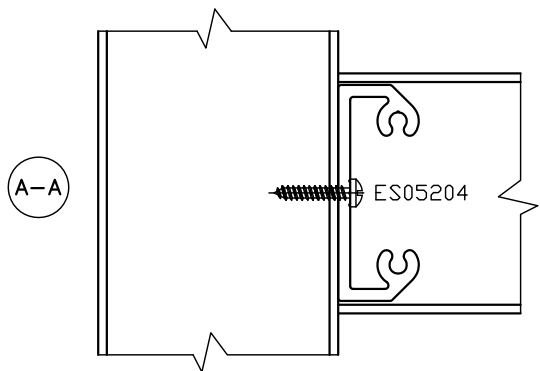
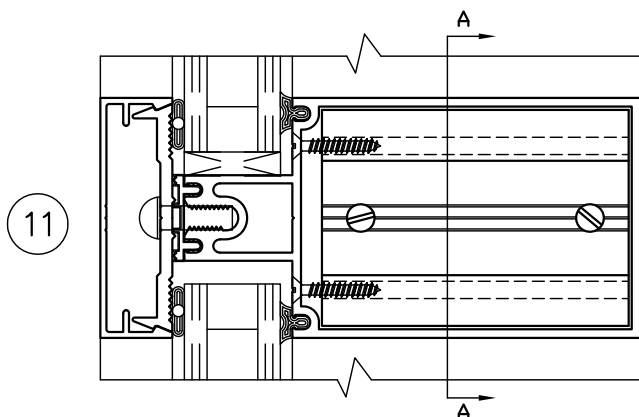
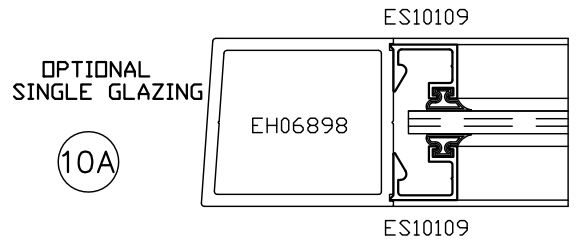
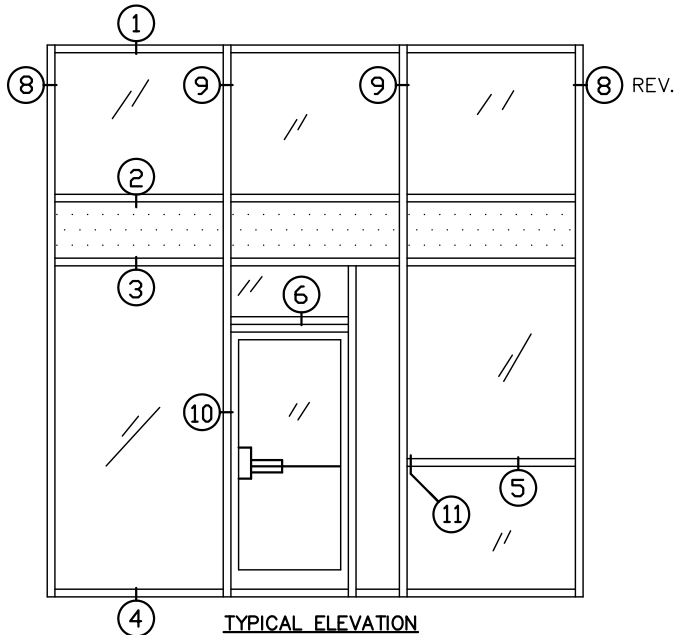
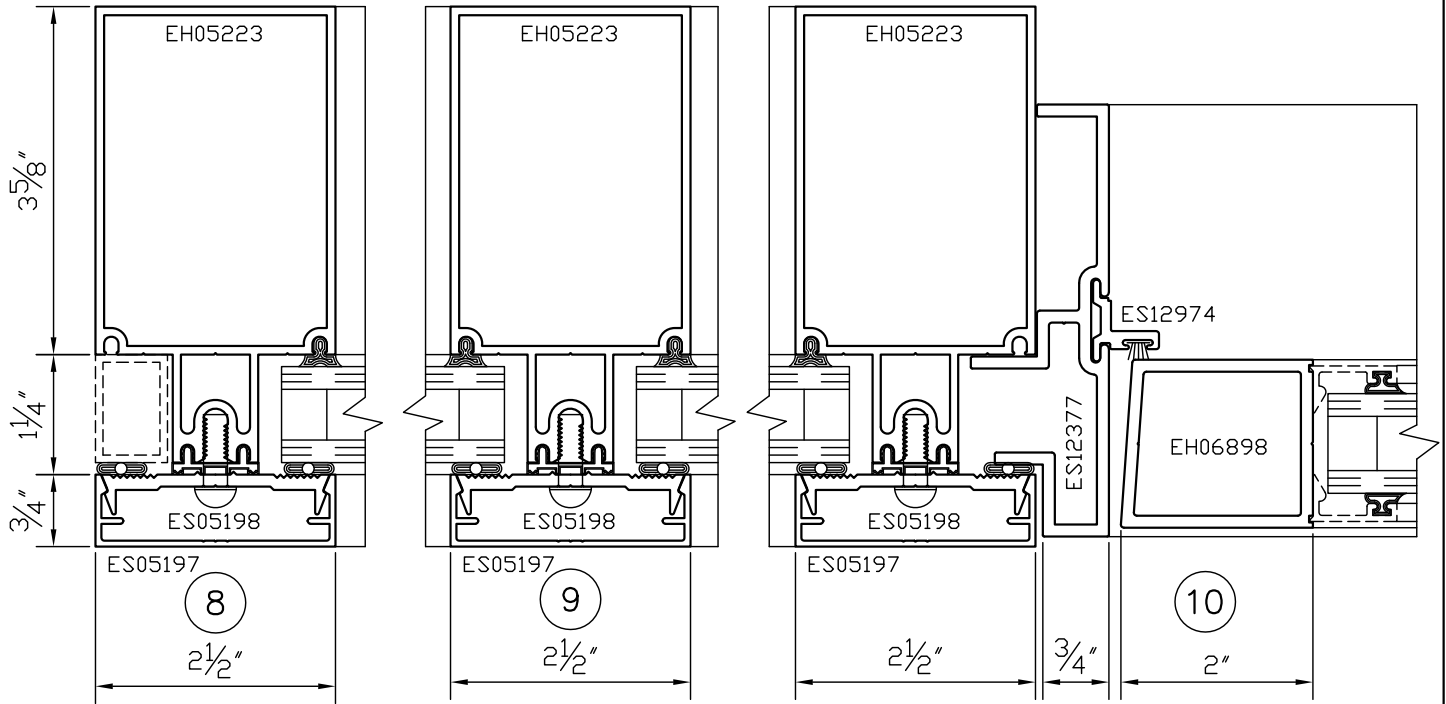

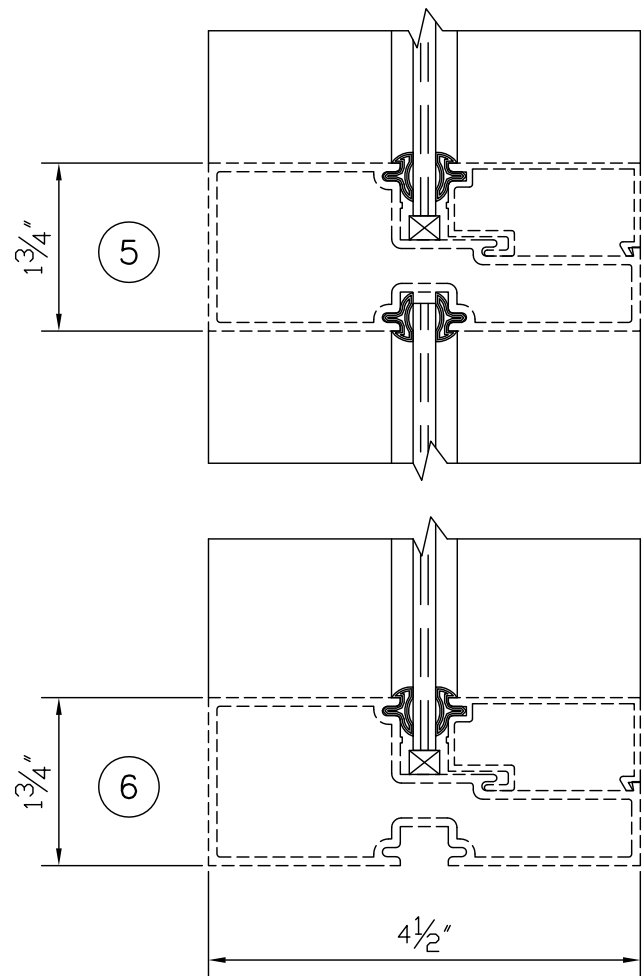
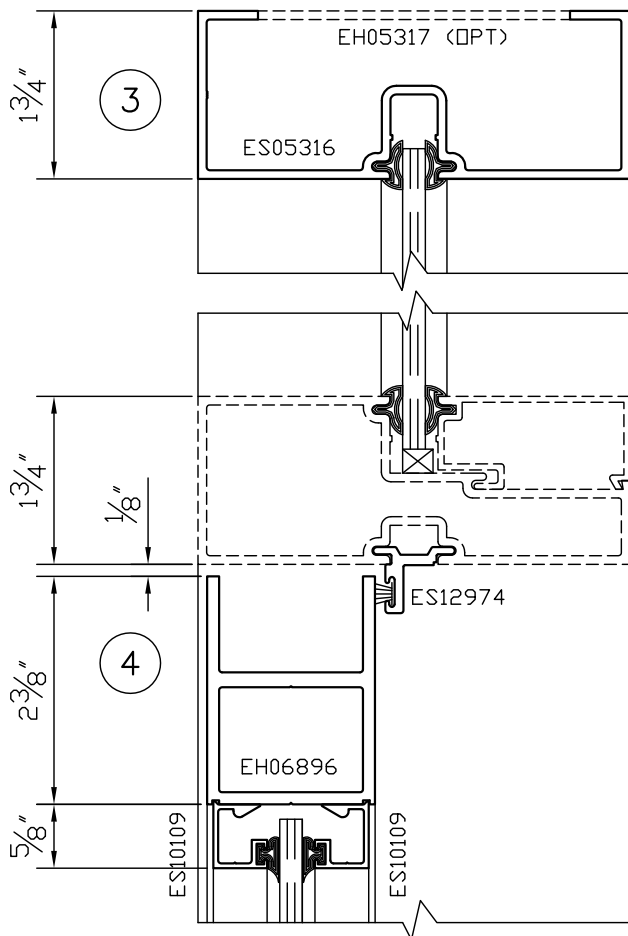
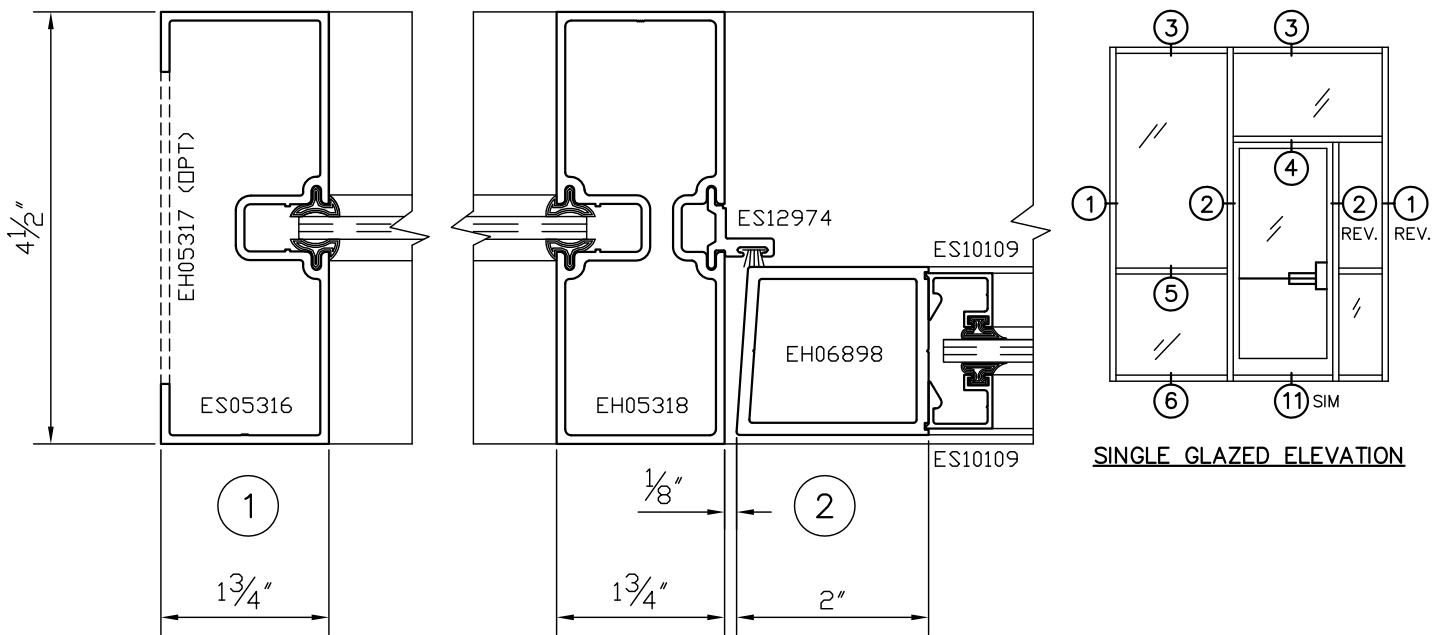

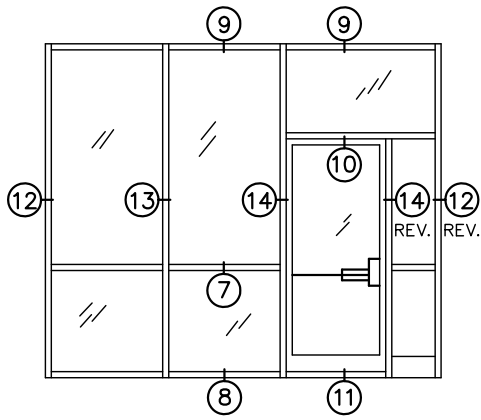

DOUBLE GLAZED ELEVATION

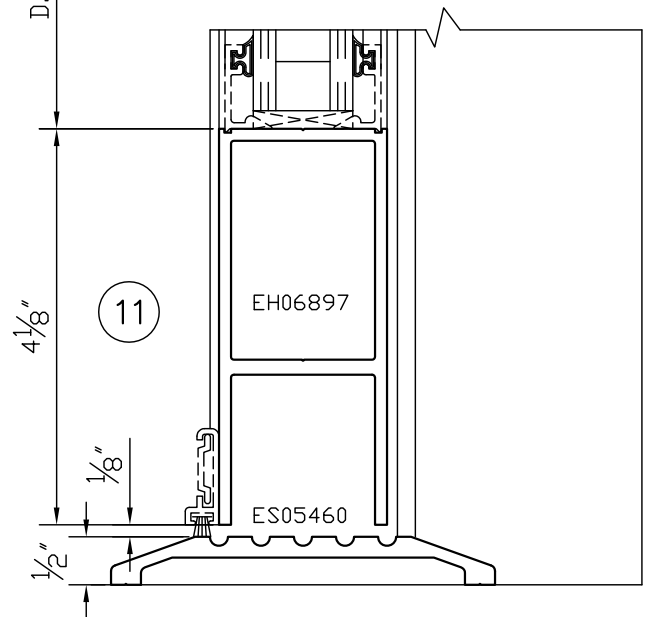
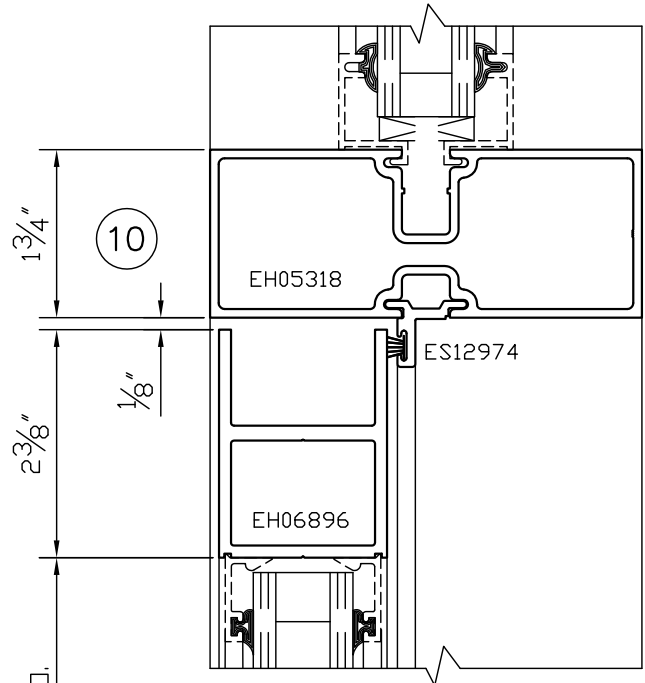
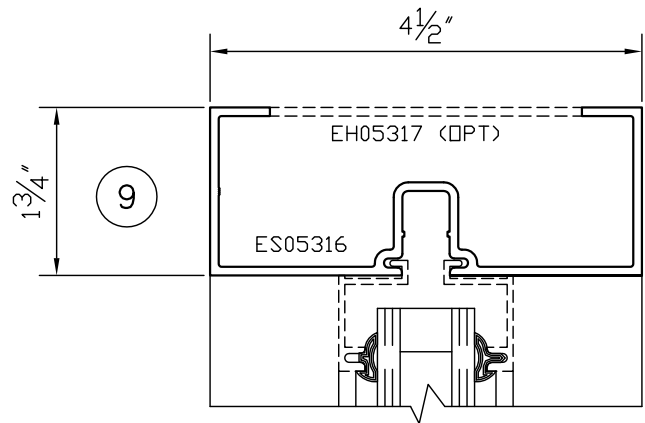
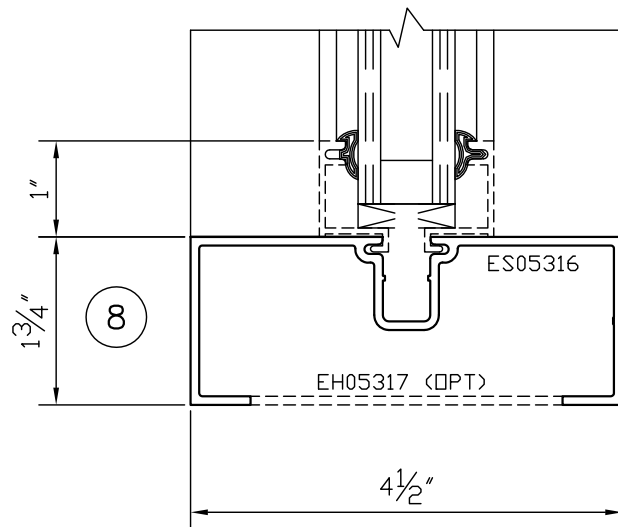
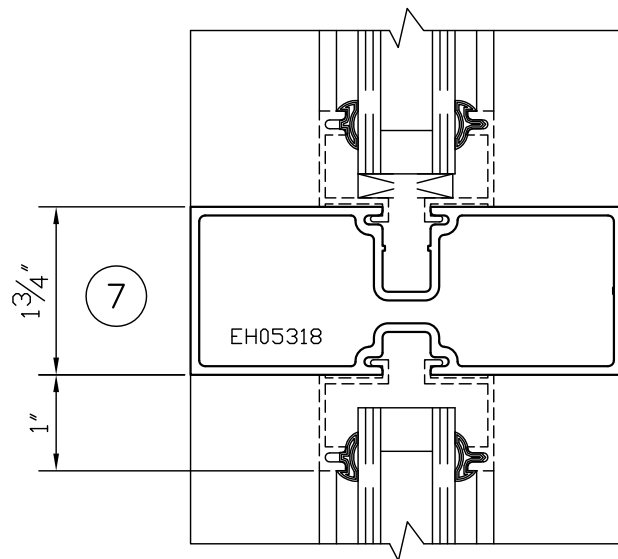

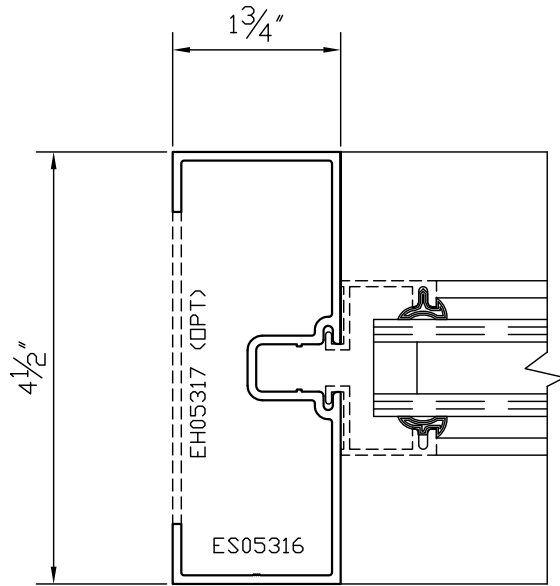

12

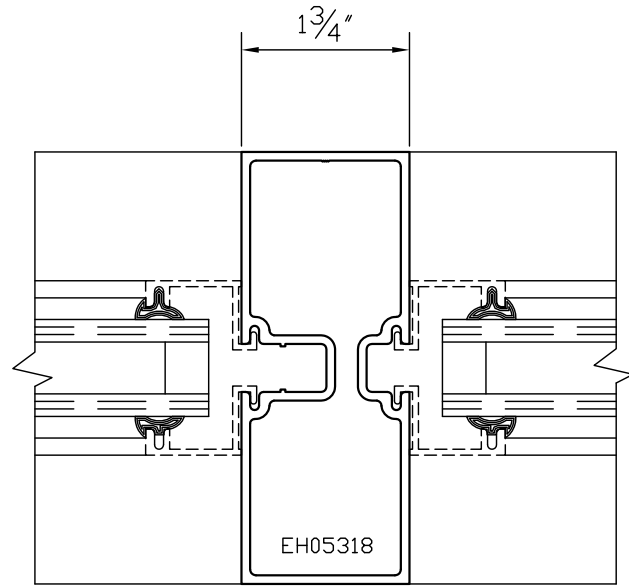

13

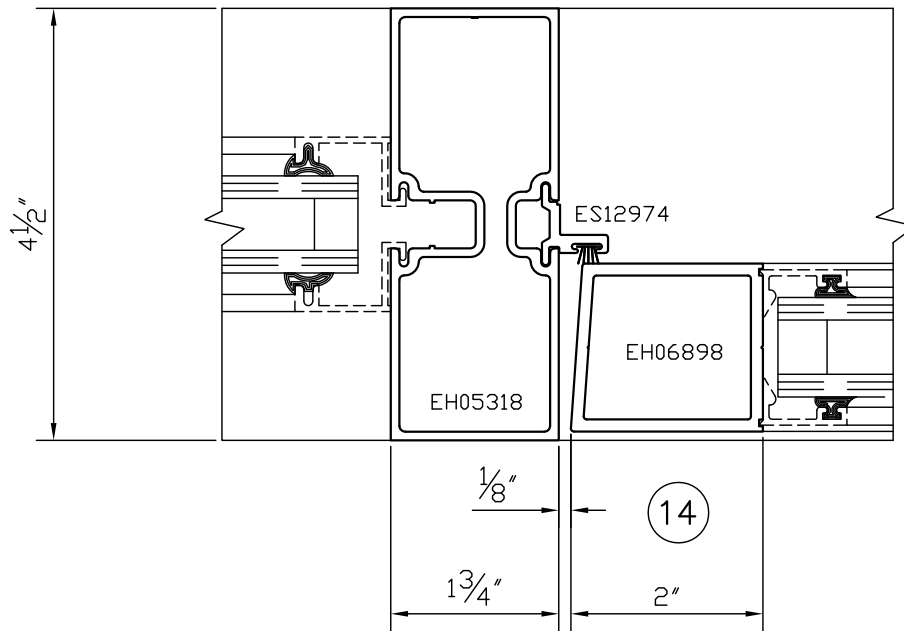

14

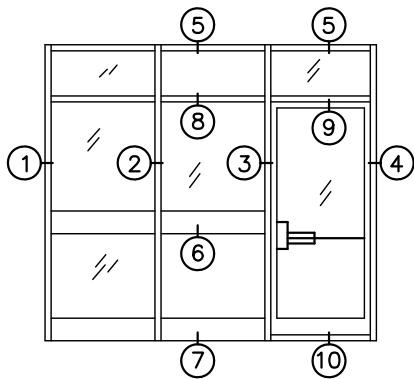

SINGLE GLAZED ELEVATION

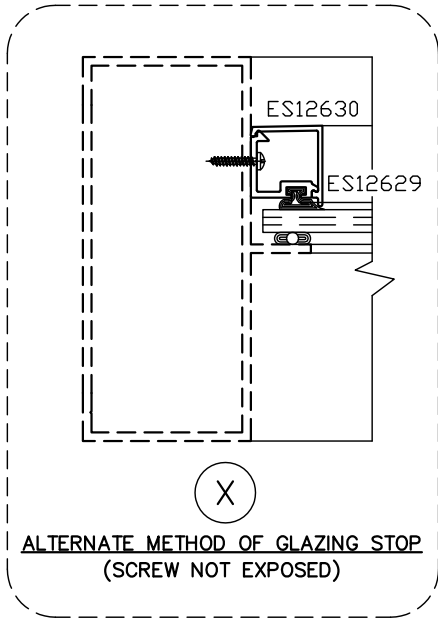

**ALTERNATE METHOD OF GLAZING STOP
(SCREW NOT EXPOSED)**

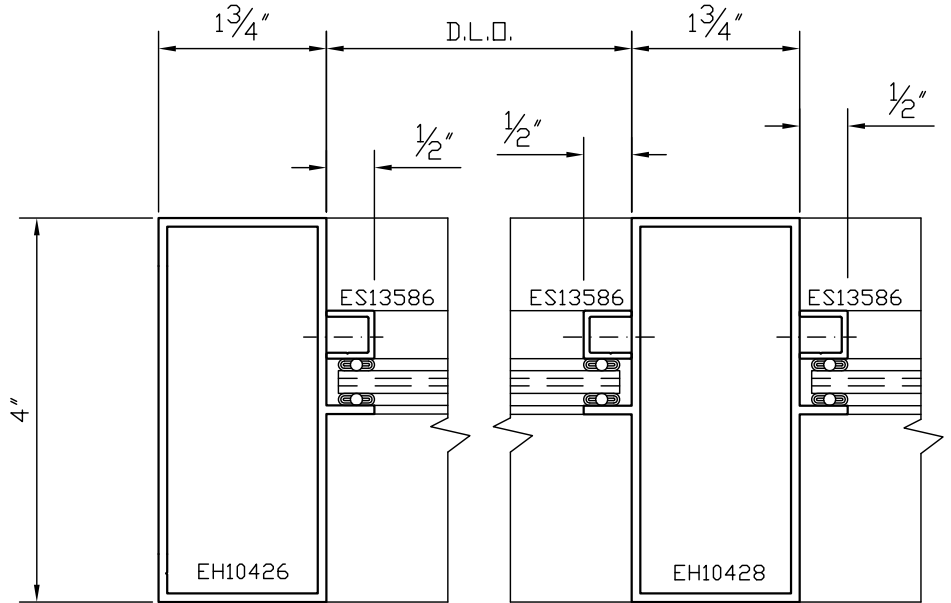

1

2

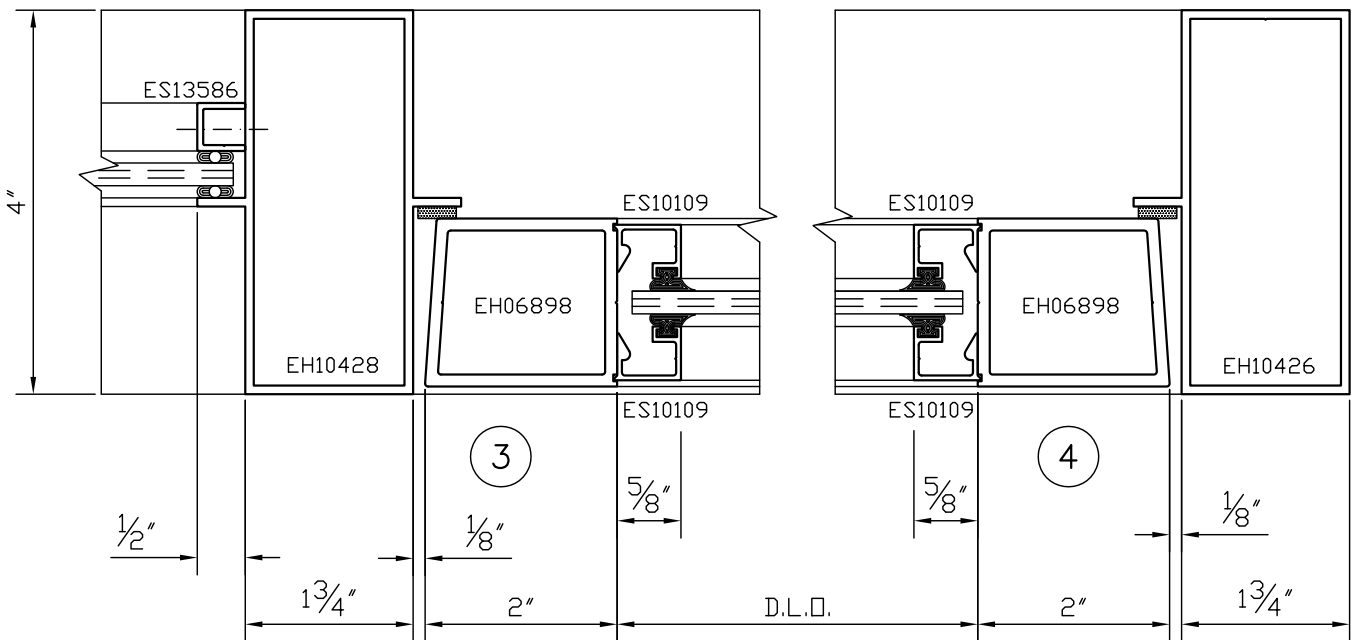

3

4

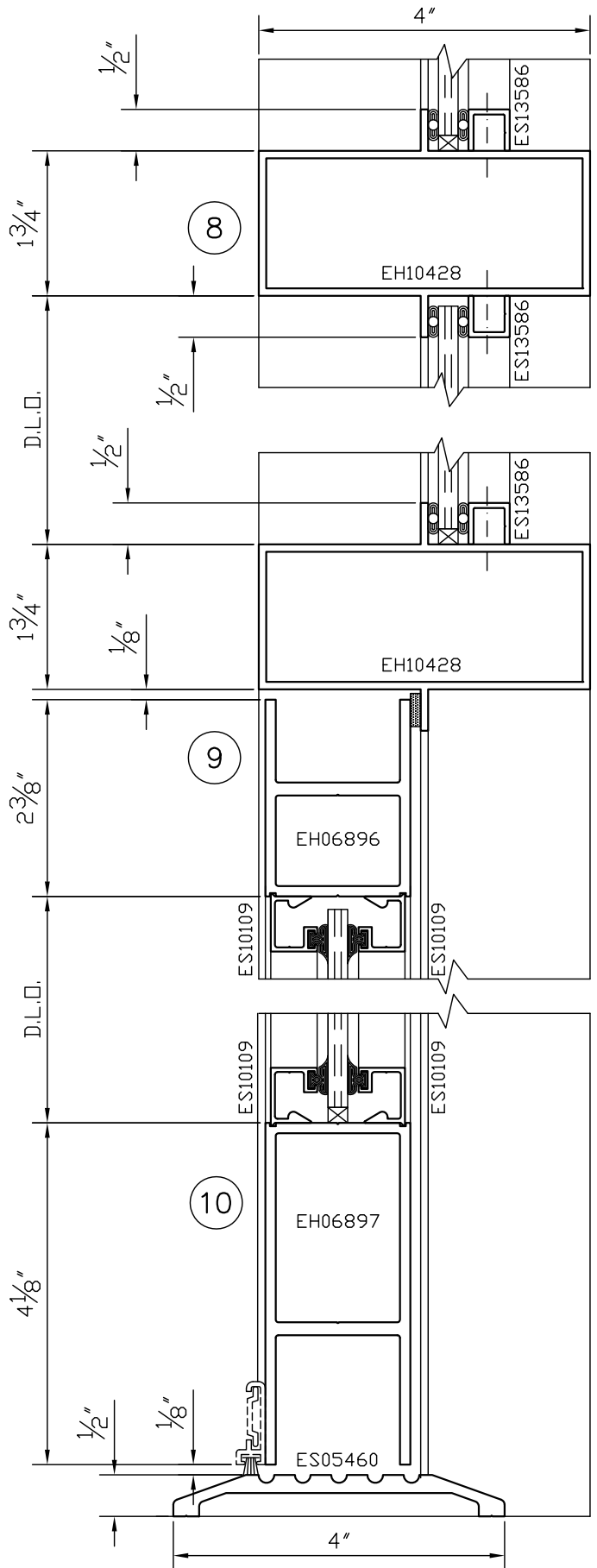
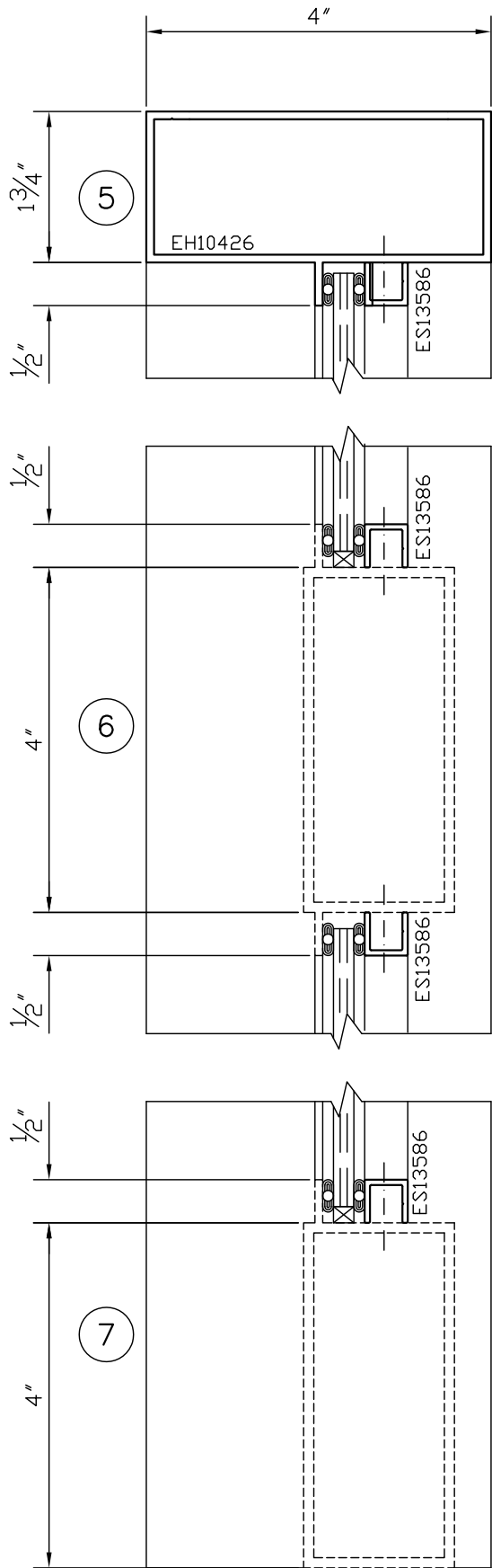

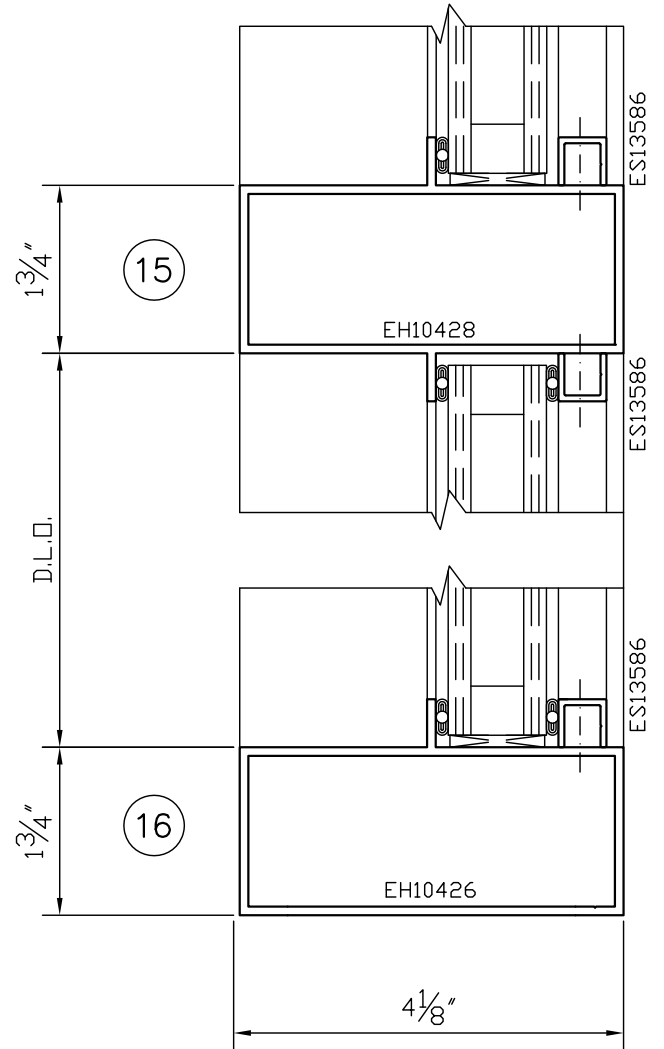
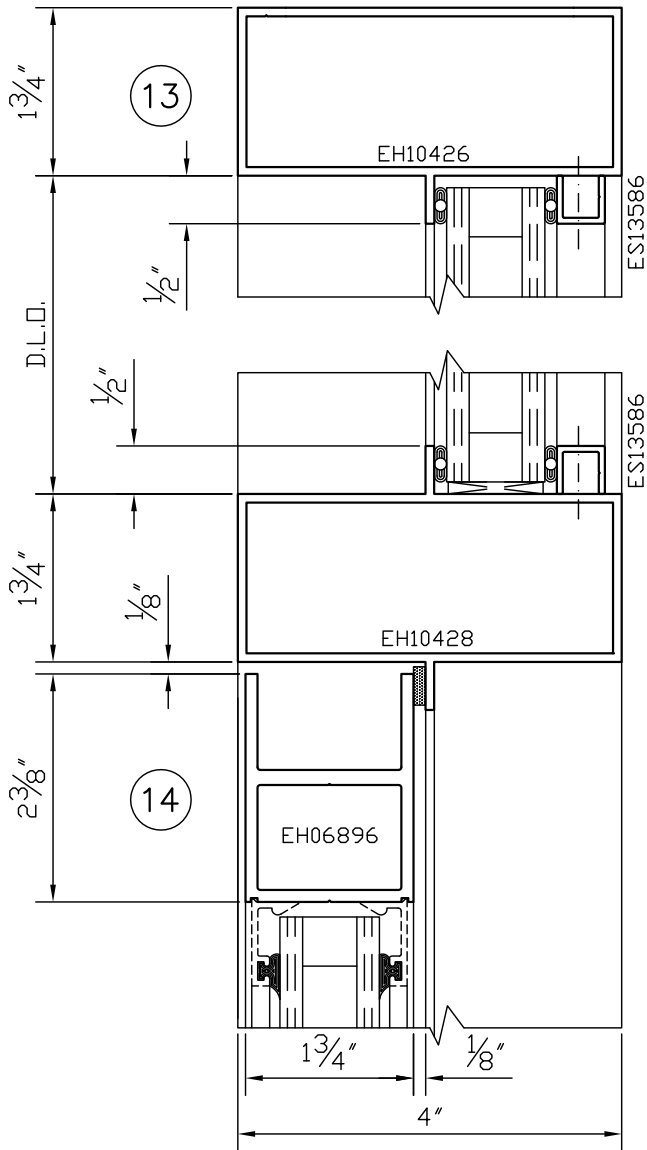
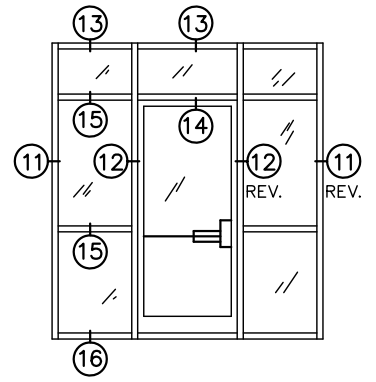
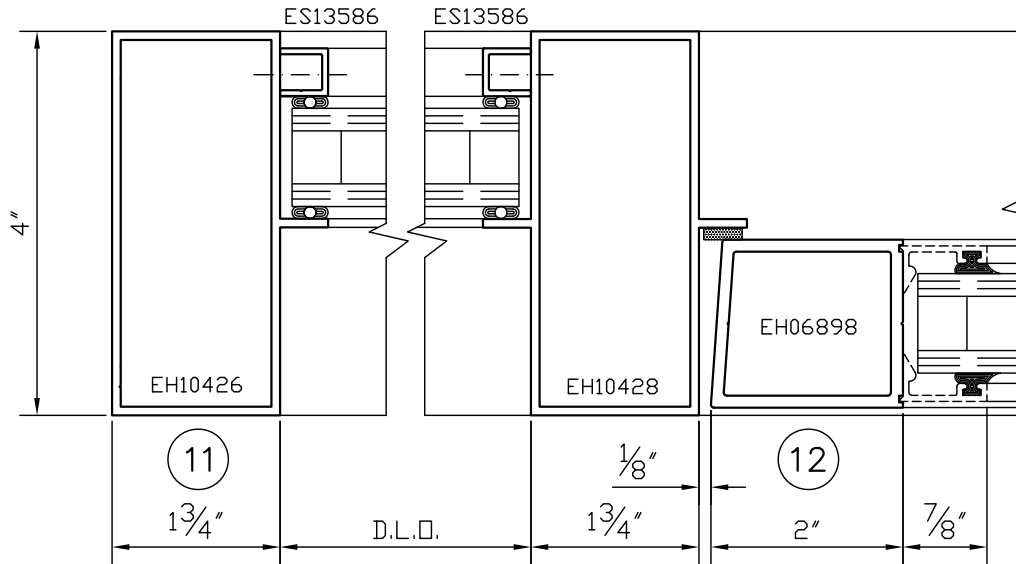

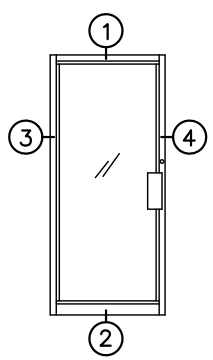
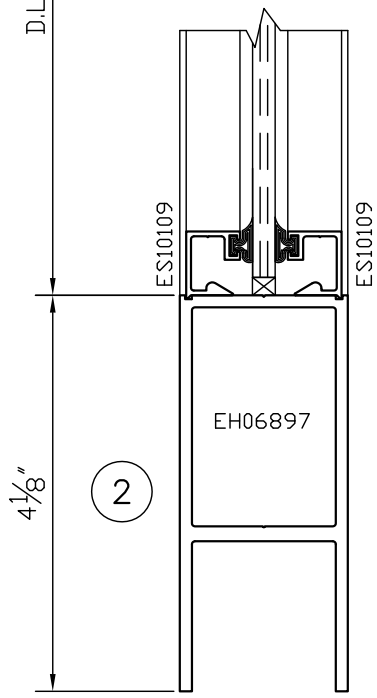
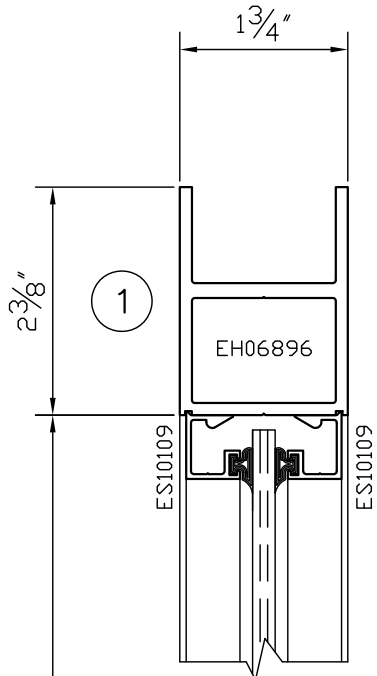

SINGLE DOOR

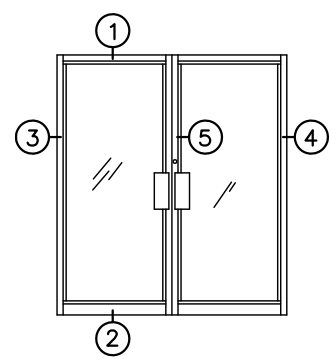

DOUBLE DOORS

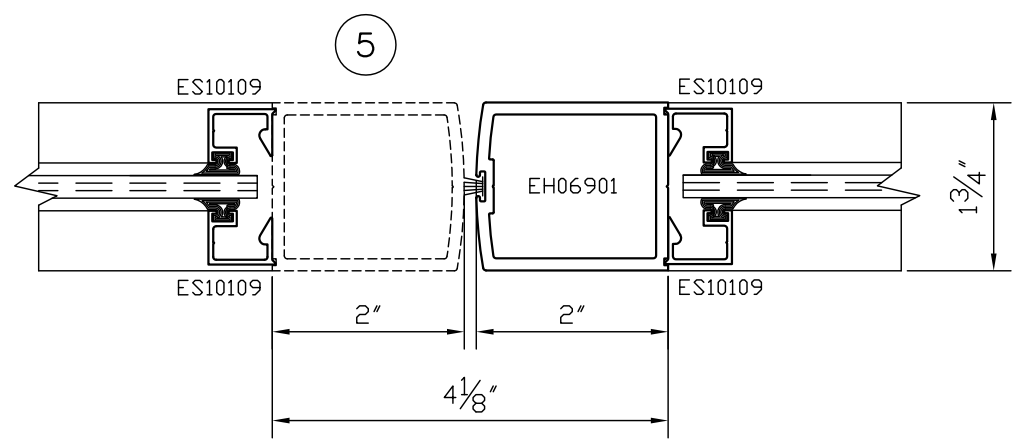
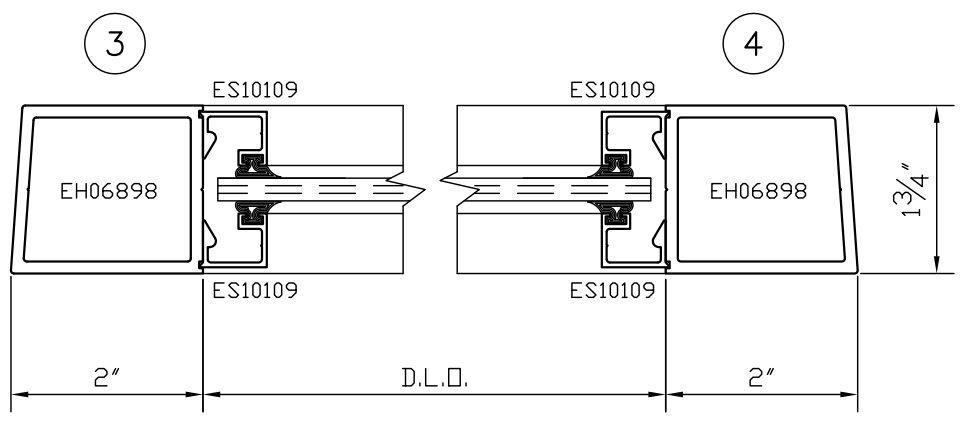

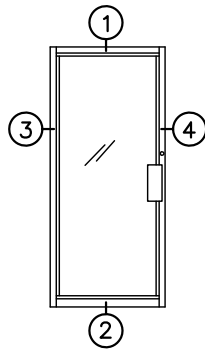
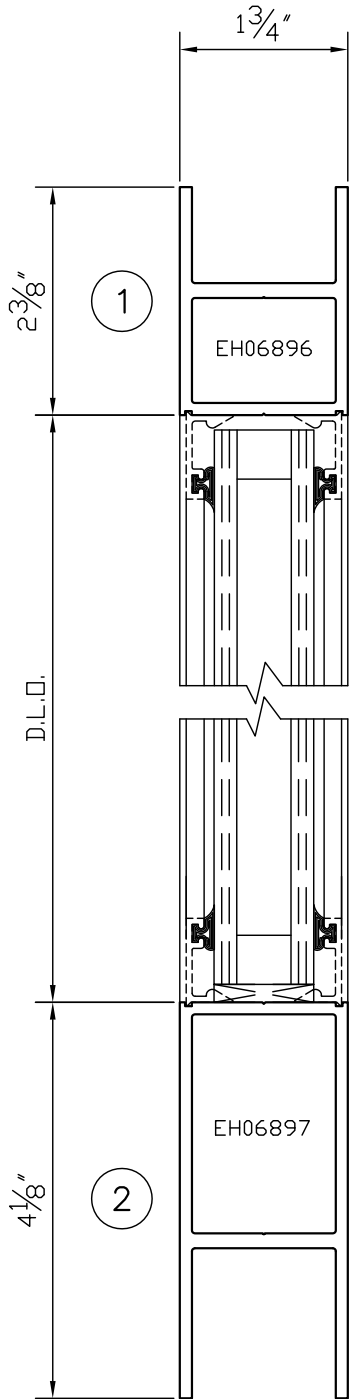

SINGLE DOOR

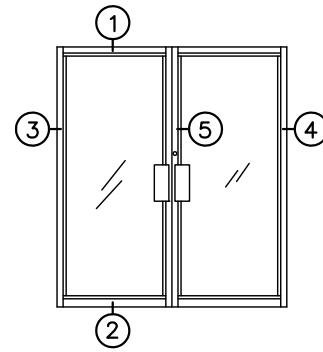

DOUBLE DOORS

