

CAN ART

ALUMINUM EXTRUSION L.P.

STANDARD SHAPES CATALOGUE

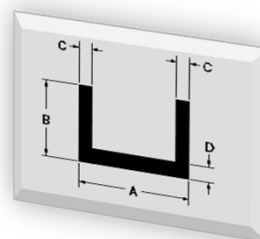
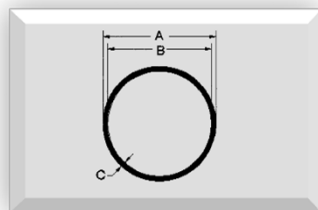
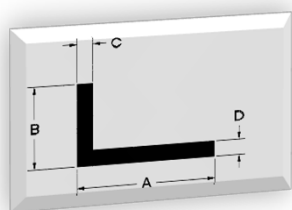

BRAMPTON PLANT
85 Parkshore Dr. Brampton,
Ont L6T 5M1 Tel. No.
(905) 791-1464 Fax No.
(905) 791-9151

www.canart.com

WINDSOR PLANT
428 Jutras Dr.
Windsor, Ont N8N 5C5
Tel. No. (519) 727-4399
Fax No. (519) 727-6434

TABLE OF CONTENTS

PIPES AND TUBES

SCHEDULE PIPE	1-1
ROUND TUBE	1-2
SQUARE TUBE (<i>SQUARE CORNERS</i>)	1-3
SQUARE TUBE (<i>ROUNDED CORNERS</i>)	1-4
RECTANGULAR TUBE (<i>SQUARE CORNERS</i>)	1-5
RECTANGULAR TUBE (<i>ROUNDED CORNERS</i>)	1-6

RODS AND BARS

ROUND ROD	2-1
SQUARE BAR (<i>SQUARE CORNERS</i>)	2-2
SQUARE BAR (<i>ROUNDED CORNERS</i>)	2-3
RECTANGULAR BAR (<i>SQUARE CORNERS</i>)	2-4
RECTANGULAR BAR (<i>ROUNDED CORNERS</i>)	2-5
RECTANGULAR BAR (<i>FULL ROUNDED CORNERS</i>)	2-6
HEX BAR	2-7

ANGLES

ANGLES (<i>SQUARE CORNERS</i>)	3-1
ANGLES (<i>SQUARE CORNERS, ROUNDED INSIDE</i>)	3-2
ANGLES (<i>ROUNDED INSIDE CORNERS</i>)	3-3

CHANNELS

CHANNELS (<i>SQUARE CORNERS</i>)	3-4
CHANNELS (<i>SQUARE CORNERS, ROUNDED INSIDE</i>)	3-5
CHANNELS (<i>ALL ROUNDED CORNERS</i>)	3-6
CHANNELS (<i>ROUNDED INSIDE, FULL ROUNDED CORNERS</i>)	3-7
CHANNELS (<i>MISCELLANEOUS</i>)	3-8

TEE SHAPES

TEE (<i>SQUARE CORNERS</i>)	4-1
TEE (<i>SQUARE CORNERS, ROUNDED INSIDE</i>)	4-2

I-BEAMS

I-BEAMS (<i>SQUARE CORNERS, ROUNDED INSIDE</i>)	4-3
---	-----

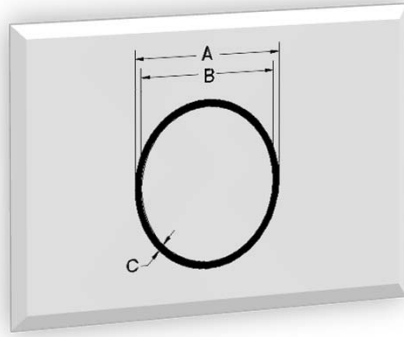

SCHEDULE PIPE 1-1

DIE NUMBER	DESCRIPTION	A	B	C	LBS/FT	KG/M
EH05696	1/2" SCHED. 40	0.840	0.622	0.109	0.295	0.440
EH05705	1/2" SCHED. 80	0.840	0.546	0.147	0.378	0.562
EH05685	3/4" SCHED. 40	1.050	0.824	0.113	0.393	0.584
EH05521	3/4" SCHED. 80	1.050	0.742	0.154	0.512	0.761
EH05239	1" SCHED. 40	1.315	1.049	0.133	0.583	0.867
EH05393	1" SCHED. 80	1.315	0.957	0.179	0.754	1.122
EH05240	1-1/4" SCHED. 40	1.660	1.380	0.140	0.789	1.174
EH05313	1-1/4" SCHED. 80	1.660	1.278	0.191	1.040	1.548
EH05812	1-1/2" SCHED. 10	1.900	1.682	0.109	0.736	1.095
EH05241	1-1/2" SCHED. 40	1.900	1.610	0.145	0.943	1.404
EH05314	1-1/2" SCHED. 80	1.900	1.500	0.200	1.260	1.876
EH05984	2" SCHED. 10	2.375	2.157	0.109	0.916	1.363
EH05236	2" SCHED. 40	2.375	2.067	0.154	1.268	1.887
EH05315	2" SCHED. 80	2.375	1.939	0.218	1.743	2.594
EH05765	2-1/2" SCHED. 10	2.875	2.635	0.120	1.246	1.855
EH05237	2-1/2" SCHED. 40	2.875	2.469	0.203	2.011	2.992
EH05869 ^{^^^}	2-1/2" SCHED. 80	2.875	2.323	0.276	2.704	4.024
EH05787	3" SCHED. 10	3.500	3.260	0.120	1.529	2.276
EH05712 ^{^^^}	3" SCHED. 40	3.500	3.068	0.216	2.630	3.913
EH05844 ^{^^^}	3" SCHED. 80	3.500	2.900	0.300	3.619	5.386

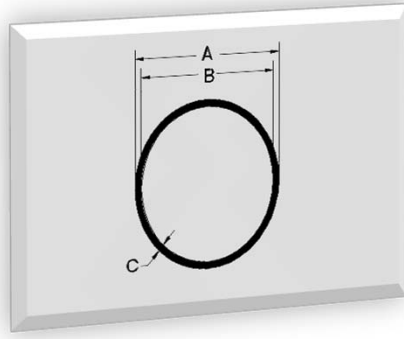

SCHEDULE PIPE 1-1

DIE NUMBER	DESCRIPTION	A	B	C	LBS/FT	KG/M
EH05868 ^{^^^}	3-1/2" SCHED. 40	4.000	3.548	0.226	3.215	4.785
EH05870 ^{^^^}	3-1/2" SCHED. 80	4.000	3.364	0.318	4.414	6.569
EH05898	4" SCHED. 10	4.500	4.260	0.120	1.948	2.900
EH05866 ^{^^^}	4" SCHED. 40	4.500	4.026	0.237	3.745	5.574
EH05871 ^{^^^}	4" SCHED. 80	4.500	3.826	0.337	5.289	7.871
EH05896 ^{^^^}	4-1/2" SCHED. 40	5.000	4.506	0.247	4.426	6.587
EH05897 ^{^^^}	5" SCHED. 40	5.563	5.047	0.258	5.160	7.679
EH05867 ^{^^^}	6" SCHED. 10	6.625	6.357	0.134	3.279	4.880
EH05976 ^{^^}	6" SCHED. 40	6.625	6.065	0.280	6.586	9.801

^{^^^}Length restriction in effect.

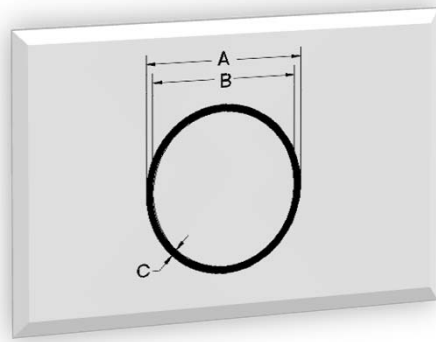

ROUND TUBE 1-2

DIE NUMBER	A	B	C	LBS/FT	KG/M
EH05245***	0.500	0.370	0.065	0.105	0.156
EH05243***	0.625	0.495	0.065	0.135	0.201
EH05404***	0.750	0.650	0.050	0.130	0.193
EH05140***	0.750	0.620	0.065	0.165	0.245
EH60494	0.750	0.584	0.083	0.209	0.310
EH04007	0.750	0.500	0.125	0.290	0.431
EH05154***	0.875	0.745	0.065	0.195	0.290
EH05560***	0.875	0.685	0.095	0.279	0.416
EH05589	0.875	0.635	0.120	0.342	0.508
EH05405***	1.000	0.900	0.050	0.176	0.262
EH05153***	1.000	0.870	0.065	0.225	0.335
EH05200	1.000	0.750	0.125	0.405	0.603
EH05451***	1.125	1.001	0.062	0.244	0.364
EH05535	1.125	0.937	0.094	0.365	0.544
EH12625	1.125	0.925	0.100	0.380	0.565
EH05538	1.125	0.875	0.125	0.463	0.690
EH05852	1.188	0.938	0.125	0.493	0.733
EH05475	1.188	0.750	0.219	0.787	1.171
EH07126	1.220	0.970	0.125	0.507	0.755
EH05406***	1.250	1.150	0.050	0.222	0.331

***Available in 6063 alloy only (Pricing Premium Applies).

^^^Length restriction in effect.

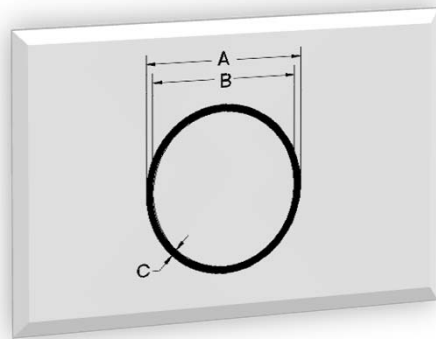

ROUND TUBE 1-2

DIE NUMBER	A	B	C	LBS/FT	KG/M
EH05152***	1.250	1.120	0.065	0.286	0.425
EH05658	1.250	1.060	0.095	0.407	0.605
EH05550	1.250	1.010	0.120	0.503	0.748
EH05113***	1.500	1.376	0.062	0.331	0.492
EH05627	1.500	1.330	0.085	0.453	0.675
EH05587	1.500	1.300	0.100	0.528	0.785
EH05522	1.500	1.250	0.125	0.637	0.948
EH07127	1.500	1.233	0.134	0.676	1.006
EH05983***	1.750	1.620	0.065	0.406	0.604
EH05633	1.750	1.584	0.083	0.522	0.776
EH05715	1.750	1.560	0.095	0.583	0.867
EH04010	1.750	1.000	0.375	1.944	2.893
EH05626***	2.000	1.900	0.050	0.361	0.538
EH05244	2.000	1.870	0.065	0.466	0.694
EH05247	2.000	1.810	0.095	0.671	0.998
EH05417	2.000	1.750	0.125	0.869	1.293
EH05944	2.000	1.626	0.187	1.257	1.870
EH05809	2.000	1.500	0.250	1.622	2.414
EH05816^^^	2.000	1.250	0.375	2.259	3.362
EH05498^^^	2.250	1.650	0.300	2.169	3.227

***Available in 6063 alloy only (Pricing Premium Applies).

^^^Length restriction in effect.

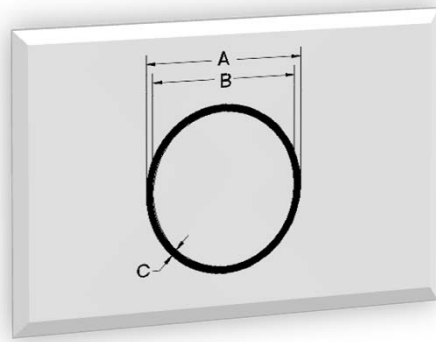

ROUND TUBE 1-2

DIE NUMBER	A	B	C	LBS/FT	KG/M
EH05048***	2.500	2.370	0.065	0.587	0.873
EH05520	2.500	2.334	0.083	0.744	1.107
EH05524	2.500	2.250	0.125	1.101	1.638
EH05253***	3.000	2.870	0.065	0.707	1.052
EH05447	3.000	2.750	0.125	1.332	1.983
EH05915	3.000	2.626	0.187	1.983	2.951
EH05807	3.250	3.060	0.095	1.111	1.654
EH04000^^^	3.250	2.750	0.250	2.780	4.138
EH05708***	4.000	3.860	0.070	1.020	1.518
EH05425	4.000	3.750	0.125	1.796	2.672
EH05916^^^	4.000	3.500	0.250	3.534	5.260
EH05932^^^	5.000	4.750	0.125	2.297	3.419
EH05951^^^	5.000	4.688	0.156	2.849	4.240
EH05952^^^	5.000	4.624	0.188	3.410	5.075
EH05953^^^	5.000	4.562	0.219	3.881	5.776
EH05937^^^	6.000	5.750	0.125	2.722	4.051
EH05933^^^	6.000	5.688	0.156	3.437	5.115
EH05957^^^	6.000	5.624	0.188	4.119	6.130
EH05973^^^	6.000	5.500	0.250	5.419	8.065

***Available in 6063 alloy only (Pricing Premium Applies).

^^^Length restriction in effect.

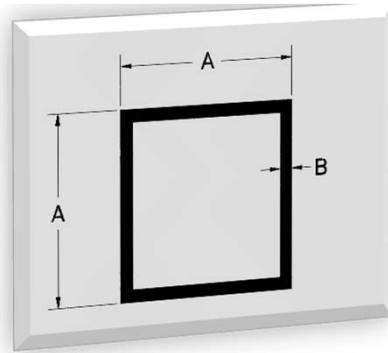

ALL CORNERS = .015" RADIUS

SQUARE TUBE 1-3 SQUARE CORNERS

DIE NUMBER	A	B	LBS/FT	KG/M
EH05991***	0.500	0.062	0.128	0.191
EH05409***	0.625	0.050	0.136	0.202
EH05582***	0.625	0.065	0.172	0.256
EH05605	0.625	0.080	0.206	0.306
EH05413***	0.750	0.055	0.180	0.269
EH05410***	0.750	0.062	0.201	0.300
EH05830	0.750	0.090	0.285	0.424
EH05747	0.750	0.125	0.369	0.549
EH05105***	1.000	0.055	0.245	0.365
EH05603***	1.000	0.062	0.274	0.409
EH05669	1.000	0.093	0.398	0.593
EH05528	1.000	0.120	0.498	0.742
EH05717	1.000	0.125	0.525	0.781
EH05491	1.250	0.093	0.508	0.756
EH05718	1.250	0.125	0.675	1.005
EH05097***	1.500	0.050	0.342	0.509
EH05731***	1.500	0.060	0.415	0.617
EH05419***	1.500	0.062	0.421	0.626
EH05273	1.500	0.075	0.504	0.751
EH05732	1.500	0.093	0.628	0.935

***Available in 6063 alloy only (Pricing Premium Applies).

^^^Length restriction in effect.

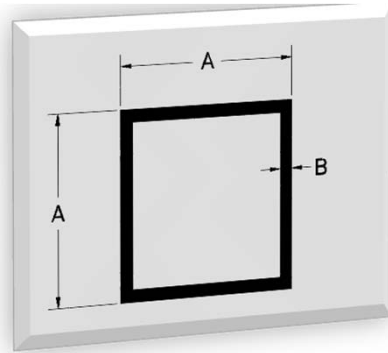

ALL CORNERS = .015" RADIUS

SQUARE TUBE 1-3 SQUARE CORNERS

DIE NUMBER	A	B	LBS/FT	KG/M
EH05414	1.500	0.125	0.811	1.207
EH05640	1.500	0.188	1.164	1.733
EH05459	1.750	0.090	0.705	1.049
EH05727	1.750	0.093	0.740	1.101
EH05632	1.750	0.125	0.959	1.426
EH05654	2.000	0.100	0.897	1.335
EH05511	2.000	0.125	1.106	1.646
EH05810	2.000	0.188	1.608	2.393
EH05450^^^	2.000	0.250	2.065	3.073
EH05474	2.500	0.120	1.348	2.006
EH05449^^^	2.500	0.188	2.052	3.053
EH05992^^^	2.500	0.250	2.655	3.951
EH05679^^^	2.564	0.188	2.144	3.191
EH05788***	2.750	0.060	0.775	1.153
EH05813	2.750	0.080	1.025	1.526
EH05707	3.000	0.085	1.169	1.740
EH05680	3.000	0.125	1.696	2.524
EH04008^^^	3.000	0.187	2.489	3.704
EH05846^^^	3.000	0.250	3.300	4.911
EH05527	4.000	0.090	1.661	2.472

***Available in 6063 alloy only (Pricing Premium Applies).

^^^Length restriction in effect.

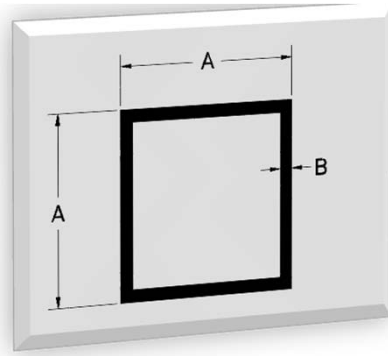

ALL CORNERS = .015" RADIUS

SQUARE TUBE 1-3 SQUARE CORNERS

DIE NUMBER	A	B	LBS/FT	KG/M
EH05950^^^	4.000	0.125	2.325	3.460
EH05431^^^	4.000	0.140	2.551	3.796
EH05845^^^	4.000	0.188	3.440	5.119
EH05842^^^	4.000	0.250	4.500	6.697
EH62680^^^	4.000	0.375	6.525	9.710
EH05930^^^	5.000	0.188	4.342	6.462
EH05941^^^	5.000	0.250	5.605	8.341
EH05931***	6.000	0.188	5.245	7.805

***Available in 6063 alloy only (Pricing Premium Applies).
^^^Length restriction in effect.

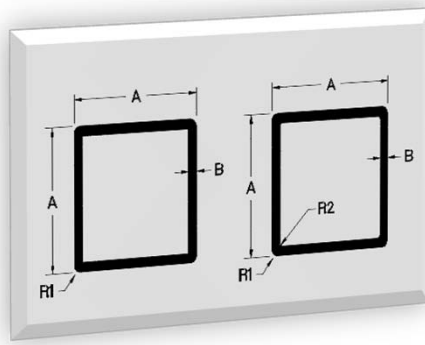

SQUARE TUBE 1-4 ROUNDED CORNERS

DIE NUMBER	A	B	R1	R2	LBS/FT	KG/M
EH05471***	0.500	0.049	0.020	0.010	0.104	0.155
EH05964***	0.750	0.040	0.125	0.085	0.128	0.190
EH05794***	0.750	0.062	0.125	0.063	0.193	0.287
EH05179***	0.875	0.065	0.065	0.010	0.244	0.363
EH05567***	1.000	0.050	0.090	0.040	0.221	0.329
EH05797***	1.000	0.050	0.125	0.073	0.217	0.324
EH05710***	1.000	0.062	0.162	0.100	0.258	0.384
EH05180***	1.000	0.065	0.125	0.062	0.275	0.409
EH05586	1.000	0.087	0.155	0.062	0.354	0.528
EH05714	1.000	0.090	0.100	0.031	0.384	0.571
EH05407	1.000	0.093	0.047	0.023	0.396	0.590
EH05278	1.000	0.112	0.120	0.015	0.453	0.675
EH05394	1.000	0.120	0.120	0.120	0.498	0.742
EH05819	1.000	0.125	0.156	0.036	0.493	0.734
EH05565	1.125	0.074	0.125	0.060	0.361	0.537
EH05968	1.250	0.120	0.240	0.120	0.596	0.887
EH05672	1.250	0.125	0.188	0.063	0.632	0.941
EH05969	1.250	0.250	0.172	0.078	1.156	1.721
EH05609***	1.500	0.061	0.188	0.127	0.402	0.598
EH05826	1.500	0.075	0.125	0.050	0.499	0.743

***Available in 6063 alloy only (Pricing Premium Applies).

^^^Length restriction in effect.

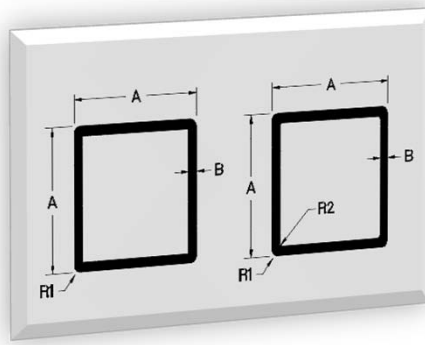

SQUARE TUBE 1-4 ROUNDED CORNERS

DIE NUMBER	A	B	R1	R2	LBS/FT	KG/M
EH05782	1.500	0.090	0.125	0.035	0.594	0.884
EH05919	1.500	0.120	0.156	0.036	0.771	1.148
EH05940	1.500	0.120	0.312	0.192	0.720	1.072
EH05420	1.500	0.120	0.370	0.250	0.706	1.051
EH05822	1.500	0.125	0.312	0.192	0.750	1.116
EH05635	1.500	0.187	0.125	0.015	1.143	1.701
EH05452	1.500	0.188	0.188	0.094	1.135	1.689
EH05681	1.700	0.135	0.225	0.090	0.954	1.420
EH05799	1.813	0.125	0.031	0.031	1.013	1.507
EH05155***	2.000	0.060	0.034	0.010	0.548	0.816
EH05925	2.000	0.090	0.375	0.285	0.751	1.118
EH05418	2.000	0.120	0.370	0.250	0.989	1.473
EH05637	2.000	0.125	0.125	0.015	1.090	1.623
EH05820	2.000	0.125	0.188	0.020	1.071	1.594
EH04041	2.000	0.187	0.250	0.062	1.541	2.293
EH05821	2.000	0.187	0.400	0.250	1.501	2.234
EH05959	2.000	0.188	0.250	0.250	1.608	2.393
EH05634^^^	2.000	0.250	0.125	0.015	2.049	3.050
EH04035	2.000	0.250	0.250	0.250	2.065	3.073
EH05960	2.000	0.250	0.375	0.125	1.938	2.885

***Available in 6063 alloy only (Pricing Premium Applies).

^^^Length restriction in effect.

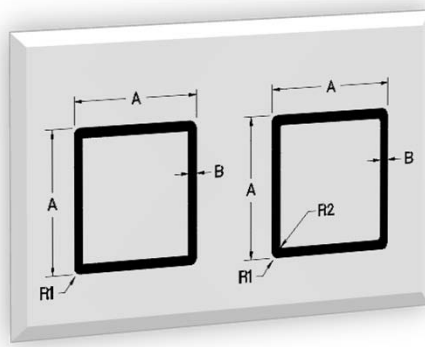

SQUARE TUBE 1-4 ROUNDED CORNERS

DIE NUMBER	A	B	R1	R2	LBS/FT	KG/M
EH61843 ^{^^^}	2.500	0.187	0.250	0.250	2.042	3.038
EH05981 ^{^^^}	2.500	0.250	0.250	0.125	2.608	3.881
EH05926	3.000	0.120	0.370	0.250	1.556	2.315
EH05823 ^{^^^}	3.000	0.187	0.125	0.125	2.483	3.695
EH05573 ^{^^^}	3.000	0.188	0.125	0.031	2.522	3.754
EH05980 ^{^^^}	3.000	0.250	0.375	0.125	3.118	4.641
EH05961 ^{^^^}	3.000	0.250	0.437	0.187	3.087	4.594
EH05962 ^{^^^}	4.000	0.188	0.375	0.188	3.276	4.875
EH05860 ^{^^^}	4.000	0.250	0.250	0.015	4.436	6.601
EH05958 ^{^^^}	4.000	0.250	0.500	0.250	4.235	6.303
EH05975 ^{^^^}	5.000	0.250	0.500	0.250	5.415	8.059

***Available in 6063 alloy only (Pricing Premium Applies).

^^^Length restriction in effect.

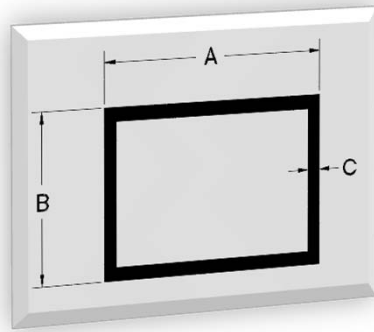

ALL CORNERS = .015" RADIUS

RECTANGULAR TUBE 1-5 SQUARE CORNERS

DIE NUMBER	A	B	C	LBS/FT	KG/M
EH05815	1.000	0.500	0.090	0.285	0.424
EH05990***	1.000	0.625	0.060	0.213	0.317
EH05643***	1.000	0.750	0.065	0.249	0.370
EH04001	1.250	1.000	0.125	0.600	0.893
EH05423***	1.500	0.625	0.062	0.293	0.436
EH05988	1.500	0.750	0.125	0.600	0.893
EH05704	1.500	1.000	0.125	0.664	0.988
EH05965***	1.750	1.000	0.040	0.256	0.381
EH05751	1.750	1.000	0.090	0.555	0.826
EH05493***	2.000	1.000	0.063	0.427	0.636
EH05639	2.000	1.000	0.095	0.630	0.938
EH05492	2.000	1.000	0.125	0.811	1.207
EH05496	2.000	1.500	0.120	0.923	1.374
EH05749	2.000	1.500	0.125	0.959	1.427
EH05709	2.000	1.500	0.180	1.334	1.985
EH04031***	2.375	1.000	0.062	0.476	0.708
EH05817	2.500	1.000	0.120	0.923	1.374
EH05272	2.500	1.500	0.120	1.065	1.584
EH05614	2.500	2.000	0.125	1.254	1.866
EH05470	3.000	1.000	0.120	1.065	1.585

***Available in 6063 alloy only (Pricing Premium Applies).

^^^Length restriction in effect.

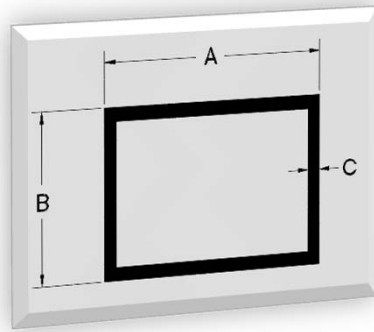

ALL CORNERS = .015" RADIUS

RECTANGULAR TUBE 1-5 SQUARE CORNERS

DIE NUMBER	A	B	C	LBS/FT	KG/M
EH05606	3.000	1.250	0.120	1.136	1.690
EH05699***	3.000	1.500	0.062	0.640	0.953
EH05650	3.000	1.500	0.125	1.254	1.866
EH05766	3.000	1.500	0.188	1.830	2.723
EH05271	3.000	2.000	0.120	1.348	2.006
EH05682^^^	3.000	2.000	0.188	2.086	3.105
EH05847^^^	3.000	2.000	0.250	2.700	4.018
EH05568	3.250	1.750	0.120	1.371	2.040
EH05985	3.500	1.000	0.070	0.720	1.072
EH13415	4.000	1.000	0.125	1.401	2.085
EH05616	4.000	1.500	0.120	1.490	2.217
EH05146	4.000	1.750	0.090	1.183	1.761
EH05774	4.000	1.750	0.125	1.650	2.455
EH05987	4.000	2.000	0.090	1.236	1.840
EH05617	4.000	2.000	0.120	1.631	2.428
EH05856	4.000	2.000	0.125	1.725	2.567
EH05694^^^	4.000	2.000	0.188	2.495	3.713
EH05986	4.000	2.000	0.250	3.245	4.829
EH05386	4.500	1.750	0.090	1.289	1.919
EH05829	4.500	1.750	0.125	1.800	2.679

***Available in 6063 alloy only (Pricing Premium Applies).

^^^Length restriction in effect.

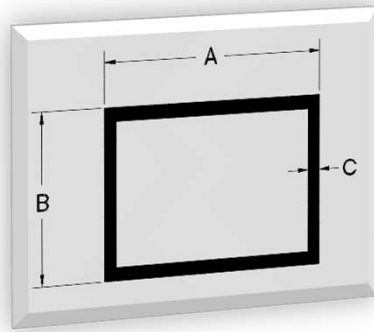

ALL CORNERS = .015" RADIUS

RECTANGULAR TUBE 1-5 SQUARE CORNERS

DIE NUMBER	A	B	C	LBS/FT	KG/M
EH05779	5.000	1.750	0.125	1.918	2.854
EH05228	5.000	2.000	0.100	1.605	2.388
EH04027	5.000	2.000	0.125	1.991	2.963
EH05998^^^	5.000	3.000	0.250	4.425	6.585
EH04018^^^	6.000	4.000	0.250	5.700	8.483

***Available in 6063 alloy only (Pricing Premium Applies).
^^^Length restriction in effect.

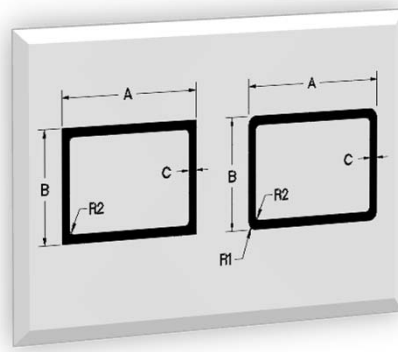

RECTANGULAR TUBE 1-6 ROUNDED CORNERS

DIE NUMBER	A	B	C	R1	R2	LBS/FT	KG/M
EH61762***	1.000	0.600	0.050	0.020	0.015	0.180	0.268
EH04012	1.000	0.750	0.120	0.156	0.036	0.404	0.602
EH05995	1.125	0.750	0.125	0.125	0.015	0.472	0.702
EH05801***	1.500	1.000	0.040	0.157	0.117	0.221	0.329
EH05543***	1.500	1.000	0.055	0.125	0.070	0.304	0.453
EH05827	1.500	1.000	0.075	0.125	0.050	0.409	0.609
EH05763	1.500	1.000	0.090	0.125	0.035	0.486	0.724
EH05949	1.625	1.125	0.125	0.125	0.031	0.735	1.094
EH05571	1.927	1.427	0.125	0.125	0.125	0.919	1.368
EH11598	2.000	0.750	0.105	0.125	0.020	0.624	0.929
EH05967***	2.000	1.000	0.040	0.125	0.085	0.272	0.404
EH05684***	2.000	1.000	0.062	0.125	0.062	0.416	0.619
EH05796	2.000	1.000	0.090	0.125	0.035	0.594	0.884
EH05713	2.000	1.000	0.093	0.125	0.032	0.613	0.912
EH05743	2.000	1.000	0.100	0.156	0.056	0.639	0.951
EH05956	2.000	1.000	0.120	0.125	0.062	0.783	1.165
EH05494	2.000	1.000	0.125	0.030	0.010	0.810	1.206
EH61384	2.000	1.000	0.125	0.125	0.015	0.809	1.204
EH05825	2.000	1.000	0.125	0.250	0.125	0.764	1.137
EH05966***	2.000	1.500	0.060	0.125	0.065	0.475	0.707

***Available in 6063 alloy only (Pricing Premium Applies).

^^^Length restriction in effect.

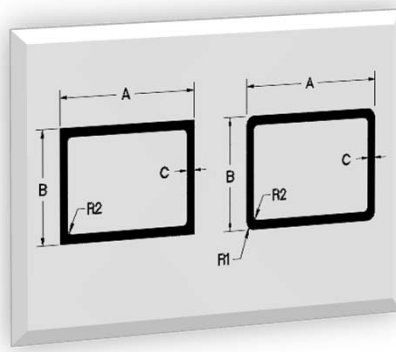

RECTANGULAR TUBE 1-6 ROUNDED CORNERS

DIE NUMBER	A	B	C	R1	R2	LBS/FT	KG/M
EH05388	2.000	1.500	0.080	0.010	0.031	0.632	0.940
EH05636	2.000	1.500	0.125	0.125	0.015	0.943	1.404
EH05572	2.250	1.750	0.125	0.125	0.125	1.125	1.674
EH05566	2.500	1.250	0.125	0.090	0.045	1.044	1.553
EH05814***	2.500	1.500	0.060	0.023	0.015	0.549	0.817
EH05790***	2.500	1.500	0.063	0.125	0.062	0.564	0.839
EH05569	2.562	2.062	0.125	0.125	0.062	1.300	1.935
EH05439***	2.750	2.250	0.050	0.030	0.010	0.577	0.859
EH05700	2.875	1.750	0.125	0.125	0.015	1.297	1.930
EH04025***	3.000	1.000	0.055	0.093	0.038	0.506	0.753
EH05744	3.000	1.000	0.100	0.156	0.056	0.875	1.303
EH05798***	3.000	1.500	0.055	0.125	0.070	0.568	0.846
EH08335	3.000	1.500	0.120	0.060	0.060	1.206	1.795
EH05608	3.000	1.500	0.120	0.125	0.031	1.212	1.803
EH05795	3.000	1.500	0.125	0.125	0.015	1.259	1.874
EH05760	3.000	1.500	0.125	0.125	0.125	1.254	1.866
EH05701	3.000	1.750	0.125	0.125	0.015	1.334	1.985
EH11533	3.000	1.750	0.188	0.125	0.015	1.925	2.865
EH05818	3.000	2.000	0.125	0.188	0.063	1.369	2.038
EH05855	3.000	2.000	0.187	0.062	0.015	2.072	3.084

***Available in 6063 alloy only (Pricing Premium Applies).

^^^Length restriction in effect.

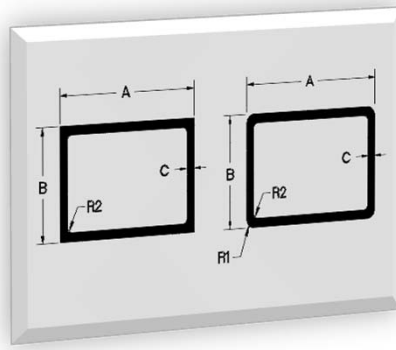

RECTANGULAR TUBE 1-6 ROUNDED CORNERS

DIE NUMBER	A	B	C	R1	R2	LBS/FT	KG/M
EH04004^^^	3.000	2.000	0.250	0.250	0.125	2.608	3.881
EH05759	4.000	1.500	0.125	0.125	0.125	1.575	2.344
EH05539	4.000	2.000	0.120	0.250	0.130	1.612	2.399
EH05972^^^	4.000	2.000	0.188	0.250	0.250	2.495	3.713
EH04002^^^	4.000	2.000	0.250	0.250	0.125	3.198	4.759
EH05702	4.500	1.250	0.125	0.125	0.015	1.634	2.432
EH04011^^^	6.000	2.000	0.120	0.250	0.130	2.151	3.202
EH05840^^^	6.000	2.000	0.125	0.031	0.031	2.325	3.460
EH05841^^^	6.000	2.000	0.188	0.031	0.031	3.440	5.119
EH04022^^^	6.000	2.000	0.188	0.250	0.063	3.315	4.933
EH05839^^^	6.000	3.000	0.125	0.031	0.031	2.625	3.907

***Available in 6063 alloy only (Pricing Premium Applies).

^^^Length restriction in effect.

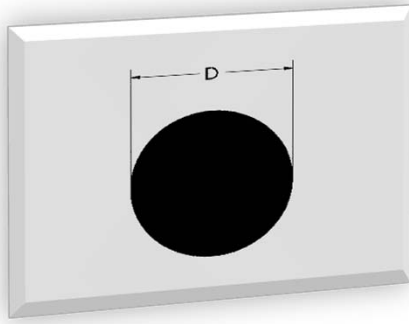

ROUND ROD 2-1

DIE NUMBER	D	LBS/FT	KG/M
ES05495***	0.313	0.091	0.135
ES05553***	0.375	0.130	0.194
ES05963	0.438	0.180	0.268
ES05233	0.500	0.232	0.345
ES05489	0.562	0.293	0.436
ES05631	0.625	0.362	0.539
ES05593	0.750	0.521	0.776
ES05276	0.875	0.710	1.056
ES05446	1.000	0.927	1.379
ES05277	1.125	1.173	1.746
ES05657	1.250	1.448	2.155
ES05758	1.375	1.752	2.608
ES05551^^^	1.500	2.085	3.103
ES05902^^^	1.750	2.886	4.295
ES05849^^^	2.000	3.770	5.610
ES05880^^^	2.250	4.771	7.101
ES05970^^^	2.500	5.792	8.620

***Available in 6063 alloy only (Pricing Premium Applies).

^^^Length restriction in effect.

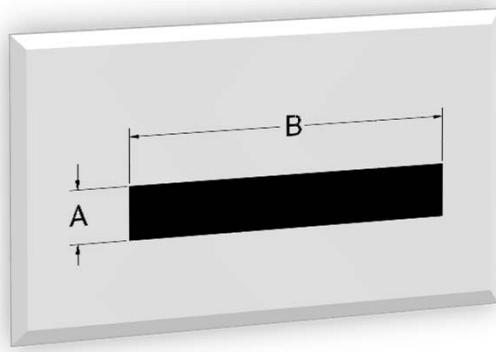

ALL CORNERS = .015" RADIUS

RECTANGULAR BAR 2-4 SQUARE CORNERS

DIE NUMBER	A	B	LBS/FT	KG/M
ES05854***	0.080	2.000	0.192	0.285
ES05772	0.090	1.000	0.108	0.161
ES05532	0.090	1.500	0.159	0.237
ES05485	0.125	0.750	0.111	0.165
ES05092	0.125	1.000	0.148	0.220
ES05638	0.125	1.250	0.184	0.274
ES05570	0.125	1.500	0.221	0.329
ES05191	0.125	2.000	0.295	0.439
ES05649	0.125	2.500	0.369	0.549
ES05411	0.125	3.000	0.442	0.659
ES05461	0.158	6.000	1.119	1.665
ES05481	0.185	1.000	0.218	0.325
ES05482	0.185	1.250	0.273	0.406
ES05483	0.185	1.500	0.327	0.487
ES05642	0.185	2.250	0.491	0.731
ES05091	0.187	0.500	0.110	0.164
ES05600	0.187	2.500	0.552	0.821
ES05914	0.187	5.000	1.122	1.669
ES07558	0.188	1.750	0.388	0.578
ES05575	0.188	2.000	0.442	0.658

***Available in 6063 alloy only (Pricing Premium Applies).

^^^Length restriction in effect.

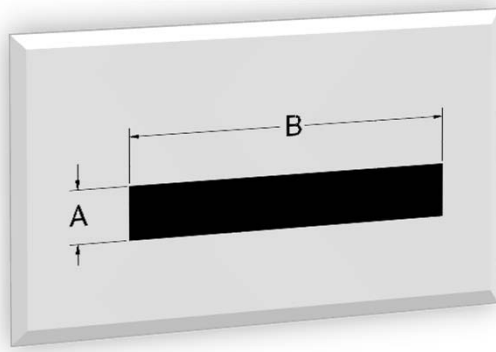

ALL CORNERS = .015" RADIUS

RECTANGULAR BAR 2-4 SQUARE CORNERS

DIE NUMBER	A	B	LBS/FT	KG/M
ES05530	0.188	3.000	0.664	0.988
ES05934	0.250	0.500	0.147	0.219
ES05513	0.250	0.750	0.221	0.329
ES05621	0.250	1.000	0.295	0.439
ES05698	0.250	1.250	0.369	0.549
ES05689	0.250	1.500	0.442	0.659
ES05536	0.250	2.000	0.590	0.878
ES05752	0.250	2.500	0.750	1.116
ES05676	0.250	3.000	0.885	1.317
ES05472	0.250	3.500	1.033	1.537
ES05497	0.250	4.000	1.180	1.756
ES05618	0.250	4.375	1.290	1.920
ES06460	0.250	4.750	1.401	2.085
ES05832	0.250	5.000	1.475	2.195
ES61905	0.250	7.000	2.100	3.125
ES05848	0.250	8.000	2.400	3.571
ES05540	0.312	5.250	1.966	2.925
ES05445	0.313	0.500	0.184	0.274
ES05078	0.375	0.500	0.221	0.329
ES05577	0.375	0.750	0.337	0.502

***Available in 6063 alloy only (Pricing Premium Applies).

^^^Length restriction in effect.

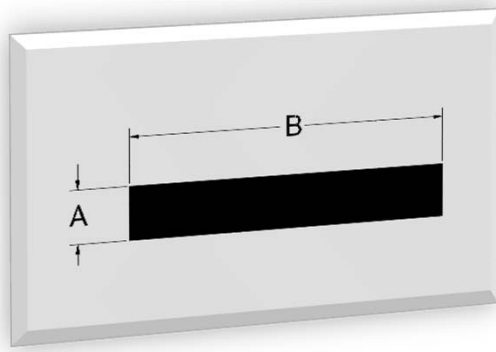

ALL CORNERS = .015" RADIUS

RECTANGULAR BAR 2-4 SQUARE CORNERS

DIE NUMBER	A	B	LBS/FT	KG/M
ES05691	0.375	1.000	0.443	0.659
ES04020	0.375	1.250	0.562	0.837
ES05690	0.375	1.500	0.664	0.988
ES05576	0.375	2.000	0.885	1.317
ES05692	0.375	2.500	1.106	1.646
ES05677	0.375	3.000	1.328	1.976
ES05613	0.375	3.500	1.549	2.305
ES05486	0.375	4.000	1.770	2.634
ES05745	0.375	4.500	1.991	2.963
ES05610^^^	0.375	5.000	2.212	3.293
ES05792^^^	0.375	6.000	2.700	4.018
ES05443	0.500	0.625	0.369	0.548
ES05574	0.500	0.750	0.442	0.658
ES08615	0.500	1.000	0.590	0.878
ES13529	0.500	1.250	0.750	1.116
ES05777	0.500	1.500	0.900	1.339
ES05242	0.500	2.000	1.180	1.756
ES05651	0.500	2.500	1.475	2.195
ES05421	0.500	3.000	1.770	2.634
ES04017^^^	0.500	3.500	2.100	3.125

***Available in 6063 alloy only (Pricing Premium Applies).

^^^Length restriction in effect.

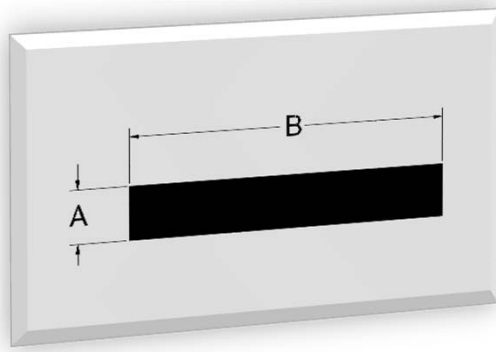

ALL CORNERS = .015" RADIUS

RECTANGULAR BAR 2-4 SQUARE CORNERS

DIE NUMBER	A	B	LBS/FT	KG/M
ES05583^^^	0.500	4.000	2.360	3.512
ES05559^^^	0.500	5.000	2.950	4.390
ES05851^^^	0.500	6.000	3.600	5.357
ES05863^^^	0.500	8.000	4.800	7.143
ES05465	0.563	0.750	0.498	0.741
ES04026	0.625	1.500	1.106	1.646
ES04039	0.625	2.500	1.875	2.790
ES04014^^^	0.625	3.000	2.250	3.348
ES04030^^^	0.625	6.000	4.425	6.585
ES05549	0.750	1.000	0.885	1.317
ES05726	0.750	1.500	1.350	2.009
ES05917	0.750	1.750	1.575	2.344
ES05741	0.750	2.000	1.800	2.679
ES04015^^^	0.750	2.500	2.250	3.348
ES05719^^^	0.750	3.000	2.700	4.018
ES05879^^^	0.750	4.000	3.600	5.357
ES05886^^^	0.750	5.000	4.500	6.697
ES05873^^^	0.750	6.000	5.400	8.036
ES05542	0.875	1.500	1.549	2.305
ES05655	1.000	1.500	1.770	2.634

***Available in 6063 alloy only (Pricing Premium Applies).

^^^Length restriction in effect.

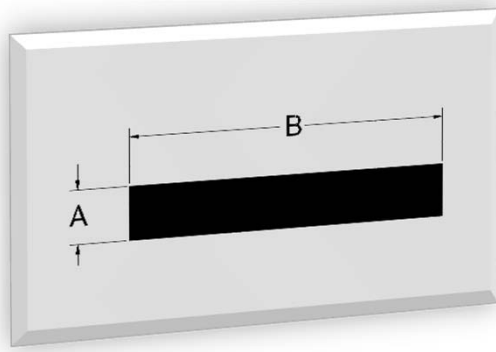

ALL CORNERS = .015" RADIUS

RECTANGULAR BAR 2-4 SQUARE CORNERS

DIE NUMBER	A	B	LBS/FT	KG/M
ES05740^^^	1.000	2.000	2.400	3.572
ES05883^^^	1.000	2.500	3.000	4.464
ES05850^^^	1.000	3.000	3.600	5.357
ES04023^^^	1.000	3.500	4.200	6.250
ES05885^^^	1.000	4.000	4.800	7.143
ES63347^^^	1.000	5.000	5.900	8.780
ES04016^^^	1.250	1.500	2.250	3.348
ES04038^^^	1.250	2.000	2.950	4.390
ES04036^^^	1.250	3.000	4.425	6.585
ES04037^^^	1.250	4.000	5.900	8.780
ES04003^^^	1.250	5.000	7.500	11.161
ES05978^^^	1.500	2.000	3.600	5.357
ES05884^^^	1.500	2.500	4.500	6.697
ES05979^^^	1.500	3.000	5.400	8.036
ES05882^^^	1.750	2.000	4.200	6.250
ES05872^^^	1.750	2.500	5.250	7.813
ES05977^^^	2.000	3.000	7.200	10.715

***Available in 6063 alloy only (Pricing Premium Applies).

^^^Length restriction in effect.



RECTANGULAR BAR 2-5 ROUNDED CORNERS

DIE NUMBER	A	B	R	LBS/FT	KG/M
ES05581	0.090	2.250	0.031	0.238	0.354
ES05508	0.187	2.500	0.030	0.552	0.882
ES05502	0.187	6.000	0.030	1.323	1.969
ES05454	0.188	1.250	0.030	0.276	0.410
ES05514	0.188	4.000	0.030	0.884	1.316
ES05408***	0.250	0.625	0.030	0.183	0.273
ES05453	0.250	3.000	0.030	0.884	1.316
ES05674	0.250	6.000	0.020	1.770	2.634
ES05441	0.375	2.000	0.020	0.885	1.316
ES05507	0.375	2.500	0.030	1.105	1.645
ES05466	0.375	3.000	0.030	1.327	1.974
ES05517	0.375	3.250	0.030	1.437	2.139
ES63348^^^	1.000	6.000	0.125	7.064	10.513

***Available in 6063 alloy only (Pricing Premium Applies).

^^^Length restriction in effect.

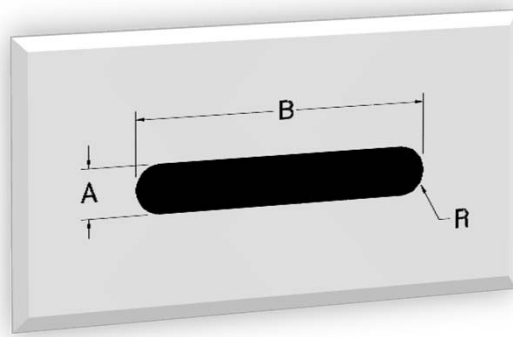

RECTANGULAR BAR 2-6 FULL ROUNDED CORNERS

DIE NUMBER	A	B	R	LBS/FT	KG/M
ES05448	0.125	1.250	FULL	0.180	0.268
ES05440	0.125	1.500	FULL	0.217	0.323
ES05050	0.250	1.500	FULL	0.427	0.635
ES05663	0.250	2.000	FULL	0.584	0.869
ES05724	0.250	2.500	FULL	0.722	1.074
ES05971	0.250	3.500	FULL	1.017	1.513
ES05943^^^	0.375	8.000	FULL	3.504	5.215
ES05912	0.500	3.000	FULL	1.707	2.540
ES05894^^^	0.500	4.000	FULL	2.297	3.418
ES05910^^^	0.500	6.000	FULL	3.477	5.174
ES05911^^^	0.500	8.000	FULL	4.657	6.930

***Available in 6063 alloy only (Pricing Premium Applies).
^^^Length restriction in effect.

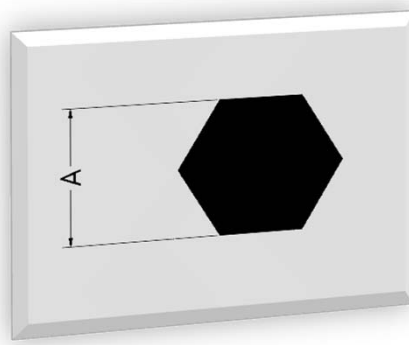

ALL CORNERS = .015" RADIUS

HEX BAR 2-7

DIE NUMBER	A	LBS/FT	KG/M
ES04006	0.625	0.399	0.594
ES05585	0.938	0.914	1.361

***Available in 6063 alloy only (Pricing Premium Applies).
^^^Length restriction in effect.

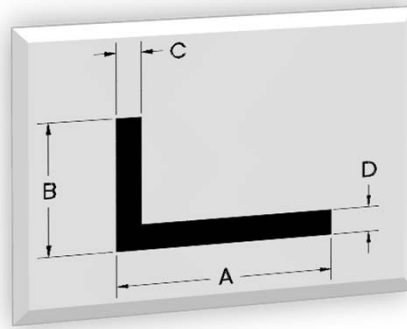

ALL CORNERS = .015" RADIUS

ANGLES 3-1 SQUARE CORNERS

DIE NUMBER	A	B	C	D	LBS/FT	KG/M
ES05468	0.500	0.500	0.125	0.125	0.129	0.192
ES05675	0.625	0.625	0.125	0.125	0.166	0.247
ES05307***	0.750	0.500	0.050	0.050	0.071	0.105
ES05479***	0.750	0.750	0.062	0.062	0.105	0.157
ES05662	0.750	0.750	0.125	0.125	0.203	0.302
ES05641***	1.000	0.625	0.062	0.062	0.114	0.170
ES05755***	1.000	0.750	0.062	0.062	0.126	0.187
ES05602	1.000	0.750	0.125	0.125	0.240	0.357
ES05563***	1.000	1.000	0.045	0.045	0.104	0.154
ES05770***	1.000	1.000	0.055	0.055	0.128	0.191
ES05102***	1.000	1.000	0.062	0.062	0.142	0.211
ES05516	1.000	1.000	0.125	0.125	0.277	0.412
ES05652	1.000	1.000	0.188	0.188	0.402	0.598
ES05653	1.000	1.000	0.250	0.250	0.516	0.768
ES05994	1.250	0.750	0.125	0.125	0.276	0.411
ES05101	1.250	1.250	0.093	0.093	0.264	0.393
ES05490	1.250	1.250	0.125	0.125	0.350	0.521
ES05673	1.250	1.250	0.250	0.250	0.664	0.988
ES05671	1.375	1.000	0.125	0.125	0.337	0.502
ES05142***	1.500	1.000	0.050	0.050	0.145	0.215

***Available in 6063 alloy only (Pricing Premium Applies).

^^^Length restriction in effect.

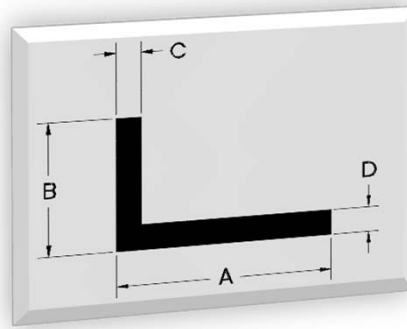

ALL CORNERS = .015" RADIUS

ANGLES 3-1 SQUARE CORNERS

DIE NUMBER	A	B	C	D	LBS/FT	KG/M
ES05769***	1.500	1.000	0.055	0.055	0.161	0.240
ES05150***	1.500	1.000	0.062	0.062	0.178	0.265
ES05534	1.500	1.000	0.090	0.090	0.256	0.381
ES05753	1.500	1.000	0.125	0.125	0.356	0.530
ES05601***	1.500	1.250	0.062	0.062	0.197	0.293
ES05811***	1.500	1.500	0.063	0.063	0.220	0.328
ES05529	1.500	1.500	0.125	0.125	0.431	0.641
ES05730	1.500	1.500	0.188	0.188	0.634	0.944
ES05151	1.500	1.500	0.250	0.250	0.811	1.207
ES05996	1.750	1.125	0.090	0.075	0.266	0.396
ES05533	1.750	1.250	0.090	0.090	0.309	0.460
ES05478***	1.750	1.750	0.062	0.062	0.252	0.374
ES05728	1.750	1.750	0.188	0.188	0.747	1.112
ES05384***	2.000	1.000	0.050	0.050	0.174	0.259
ES05754***	2.000	1.000	0.062	0.062	0.219	0.325
ES05196	2.000	1.000	0.095	0.095	0.326	0.485
ES05670	2.000	1.000	0.125	0.125	0.424	0.631
ES04024	2.000	1.000	0.187	0.187	0.620	0.923
ES05729	2.000	1.500	0.188	0.188	0.747	1.112
ES05094	2.000	2.000	0.078	0.078	0.361	0.537

***Available in 6063 alloy only (Pricing Premium Applies).

^^^Length restriction in effect.

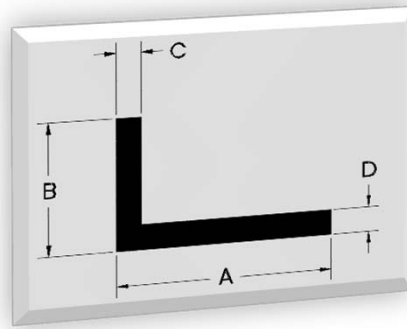

ALL CORNERS = .015" RADIUS

ANGLES 3-1 SQUARE CORNERS

DIE NUMBER	A	B	C	D	LBS/FT	KG/M
ES05604	2.000	2.000	0.125	0.125	0.572	0.851
ES05802	2.000	2.000	0.188	0.188	0.845	1.258
ES05664	2.000	2.000	0.250	0.250	1.125	1.674
ES05982	2.250	1.125	0.125	0.125	0.487	0.725
ES06351	2.370	1.600	0.250	0.250	1.097	1.633
ES05646	2.500	1.000	0.125	0.125	0.498	0.741
ES05526	2.500	1.125	0.070	0.070	0.294	0.437
ES04032	2.500	1.250	0.125	0.125	0.544	0.809
ES05644	2.500	1.500	0.125	0.125	0.571	0.850
ES05806	2.500	2.000	0.188	0.188	0.972	1.446
ES05397	2.500	2.500	0.080	0.080	0.464	0.691
ES05853	2.500	2.500	0.125	0.125	0.731	1.088
ES05775	3.000	1.000	0.125	0.125	0.581	0.865
ES05837	3.000	1.250	0.188	0.188	0.899	1.337
ES60290***	3.000	1.500	0.062	0.062	0.330	0.491
ES05473	3.000	2.000	0.075	0.075	0.436	0.649
ES04042	3.000	2.000	0.125	0.125	0.719	1.070
ES05467	3.000	2.000	0.188	0.188	1.065	1.585
ES05434	3.000	2.000	0.250	0.250	1.401	2.085
ES05928^^^	3.000	2.000	0.375	0.375	2.046	3.045

***Available in 6063 alloy only (Pricing Premium Applies).

^^^Length restriction in effect.

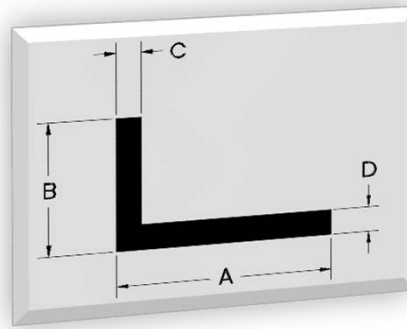

ALL CORNERS = .015" RADIUS

ANGLES 3-1 SQUARE CORNERS

DIE NUMBER	A	B	C	D	LBS/FT	KG/M
ES05387***	3.000	3.000	0.075	0.075	0.524	0.780
ES05648	3.000	3.000	0.125	0.125	0.867	1.290
ES05611	3.000	3.000	0.250	0.250	1.696	2.524
ES05597***	3.500	1.063	0.063	0.063	0.334	0.498
ES05584	4.000	1.000	0.125	0.125	0.731	1.088
ES05833	4.000	1.625	0.125	0.125	0.811	1.207
ES05800	4.000	2.000	0.125	0.125	0.866	1.289
ES05767	4.750	2.000	0.188	0.188	1.480	2.203

***Available in 6063 alloy only (Pricing Premium Applies).
^^^Length restriction in effect.

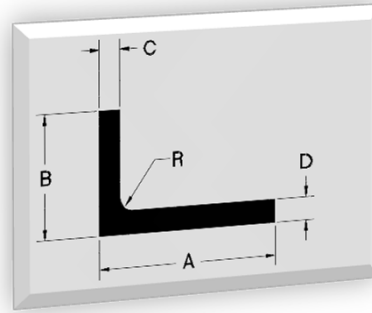

SQUARE CORNERS = .015" RADIUS

ANGLES 3-2

SQUARE CORNERS, ROUNDED INSIDE

DIE NUMBER	A	B	C	D	R	LBS/FT	KG/M
ES05666	1.000	1.000	0.125	0.125	0.125	0.281	0.417
ES05888	1.000	1.000	0.188	0.188	0.188	0.411	0.611
ES05938	1.000	1.000	0.250	0.250	0.250	0.532	0.791
ES05545	1.250	1.250	0.125	0.125	0.125	0.354	0.527
ES05546	1.250	1.250	0.188	0.188	0.187	0.521	0.775
ES05939	1.250	1.250	0.250	0.250	0.250	0.679	1.011
ES05761	1.500	0.750	0.090	0.090	0.090	0.231	0.344
ES05512	1.500	1.000	0.188	0.188	0.188	0.521	0.775
ES05805	1.500	1.500	0.125	0.125	0.125	0.428	0.637
ES05687	1.500	1.500	0.188	0.188	0.188	0.633	0.942
ES05547	1.500	1.500	0.250	0.250	0.250	0.827	1.231
ES05554	1.750	0.750	0.090	0.090	0.090	0.258	0.384
ES05946	1.750	1.750	0.250	0.250	0.250	0.974	1.450
ES05955	2.000	1.000	0.125	0.125	0.125	0.428	0.637
ES05875	2.000	1.500	0.188	0.188	0.188	0.743	1.106
ES05725	2.000	1.500	0.250	0.250	0.250	0.975	1.450
ES05874	2.000	2.000	0.125	0.125	0.125	0.575	0.856
ES05620	2.000	2.000	0.187	0.187	0.187	0.850	1.265
ES05430	2.000	2.000	0.250	0.250	0.250	1.122	1.670
ES05936	2.000	2.000	0.375	0.375	0.375	1.639	2.440

***Available in 6063 alloy only (Pricing Premium Applies).

^^^Length restriction in effect.

Revised 30/05/2017

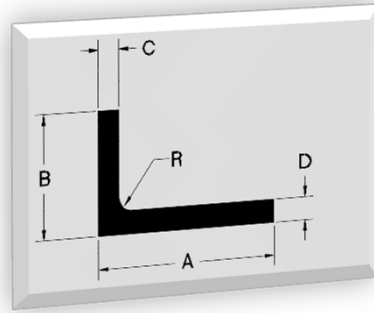

SQUARE CORNERS = .015" RADIUS

ANGLES 3-2 SQUARE CORNERS, ROUNDED INSIDE

DIE NUMBER	A	B	C	D	R	LBS/FT	KG/M
ES05785	2.250	2.125	0.250	0.250	0.250	1.232	1.834
ES05864	2.500	1.500	0.250	0.250	0.250	1.141	1.698
ES04019	2.500	2.000	0.250	0.250	0.250	1.291	1.921
ES05548	2.500	2.500	0.250	0.250	0.250	1.417	2.109
ES05922 ^{^^^}	2.500	2.500	0.375	0.375	0.375	2.082	3.098
ES05803	3.000	2.000	0.188	0.188	0.188	1.076	1.602
ES05555	3.000	2.000	0.250	0.250	0.250	1.417	2.109
ES05889	3.000	3.000	0.188	0.188	0.188	1.298	1.932
ES05469	3.000	3.000	0.250	0.250	0.250	1.712	2.548
ES05862 ^{^^^}	3.000	3.000	0.375	0.375	0.375	2.567	3.821
ES05876 ^{^^^}	3.000	3.000	0.500	0.500	0.500	3.308	4.923
ES05942 ^{^^^}	3.500	2.500	0.375	0.375	0.375	2.524	3.757
ES05789 ^{^^^}	3.500	3.500	0.250	0.250	0.250	2.007	2.987
ES04034 ^{^^^}	3.500	3.500	0.375	0.375	0.375	2.967	4.415
ES04029	4.000	2.000	0.250	0.250	0.250	1.712	2.547
ES05895 ^{^^^}	4.000	3.000	0.250	0.250	0.250	2.007	2.987
ES05843 ^{^^^}	4.000	3.000	0.375	0.375	0.375	3.017	4.490
ES05904 ^{^^^}	4.000	4.000	0.250	0.250	0.250	2.302	3.426
ES05861 ^{^^^}	4.000	4.000	0.375	0.375	0.375	3.467	5.160
ES05913 ^{^^^}	4.000	4.000	0.500	0.500	0.500	4.488	6.679

***Available in 6063 alloy only (Pricing Premium Applies).

^^^Length restriction in effect.

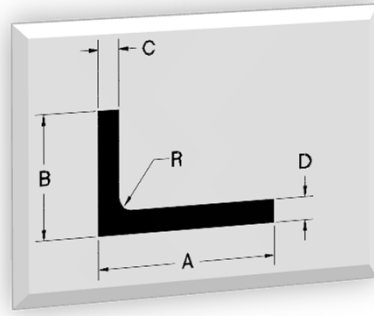

SQUARE CORNERS = .015" RADIUS

ANGLES 3-2

SQUARE CORNERS, ROUNDED INSIDE

DIE NUMBER	A	B	C	D	R	LBS/FT	KG/M
ES05703	4.250	1.250	0.197	0.197	0.197	1.243	1.849
ES04013^^^	5.000	2.000	0.375	0.375	0.375	2.967	4.415
ES05929	5.000	3.000	0.250	0.250	0.250	2.302	3.426
ES05890^^^	5.000	3.500	0.375	0.375	0.375	3.631	5.403
ES05891^^^	6.000	3.500	0.312	0.312	0.312	3.407	5.070
ES05906^^^	6.000	4.000	0.375	0.375	0.375	4.294	6.391
ES05989^^^	7.000	2.500	0.500	0.500	0.500	5.373	7.996
ES05999^^^	8.000	3.000	0.375	0.375	0.375	4.737	7.049

***Available in 6063 alloy only (Pricing Premium Applies).

^^^Length restriction in effect.

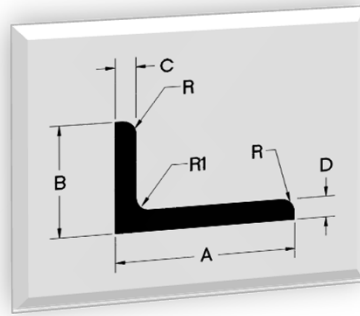

SQUARE CORNERS = .015" RADIUS

ANGLES 3-3 ROUNDED INSIDE CORNERS

DIE NUMBER	A	B	C	D	R1	R	LBS/FT	KG/M
ES05742	0.750	0.750	0.125	0.125	0.125	0.094	0.206	0.306
ES05722	1.000	1.000	0.125	0.125	0.125	0.094	0.281	0.418
ES05746	1.000	1.000	0.250	0.250	0.125	0.094	0.524	0.781
ES05750	1.250	1.250	0.125	0.125	0.188	0.125	0.357	0.532
ES05757	1.250	1.250	0.250	0.250	0.188	0.125	0.676	1.006
ES05591	1.500	1.500	0.125	0.125	0.188	0.125	0.432	0.643
ES05737	1.500	1.500	0.188	0.188	0.188	0.125	0.634	0.943
ES05716	1.500	1.500	0.250	0.250	0.250	0.250	0.809	1.204
ES05580	2.000	1.500	0.188	0.188	0.188	0.125	0.748	1.114
ES05733	2.000	1.500	0.250	0.250	0.188	0.125	0.976	1.452
ES05590	2.000	2.000	0.125	0.125	0.250	0.125	0.589	0.877
ES05734	2.000	2.000	0.188	0.188	0.250	0.125	0.866	1.289
ES05629	2.000	2.000	0.250	0.250	0.250	0.250	1.090	1.623
ES05697	2.000	2.000	0.250	0.250	0.250	0.125	1.114	1.658
ES05824	2.000	2.000	0.313	0.313	0.312	0.250	1.376	2.047
ES05557	2.500	1.500	0.187	0.187	0.250	0.187	0.854	1.271
ES05588	2.500	2.500	0.125	0.125	0.250	0.125	0.739	1.100
ES05735	2.500	2.500	0.250	0.250	0.250	0.125	1.433	2.133
ES05628^^^	2.500	2.500	0.375	0.375	0.375	0.375	2.011	2.993
ES05537	3.000	1.500	0.187	0.187	0.187	0.187	0.959	1.427

***Available in 6063 alloy only (Pricing Premium Applies).

^^^Length restriction in effect.

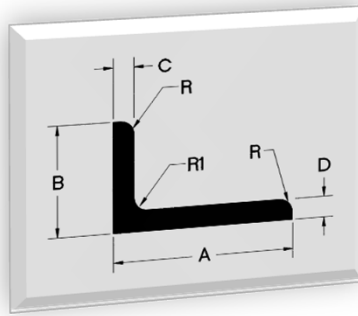

SQUARE CORNERS = .015" RADIUS

ANGLES 3-3 ROUNDED INSIDE CORNERS

DIE NUMBER	A	B	C	D	R1	R	LBS/FT	KG/M
ES05903	3.000	2.000	0.188	0.188	0.188	0.188	1.077	1.602
ES05556	3.000	2.000	0.250	0.250	0.250	0.250	1.409	2.097
ES05721	3.000	3.000	0.188	0.188	0.313	0.250	1.305	1.942
ES05736	3.000	3.000	0.250	0.250	0.312	0.250	1.718	2.557
ES05918^^^	5.000	5.000	0.250	0.250	0.375	0.250	2.929	4.359

***Available in 6063 alloy only (Pricing Premium Applies).
^^^Length restriction in effect.

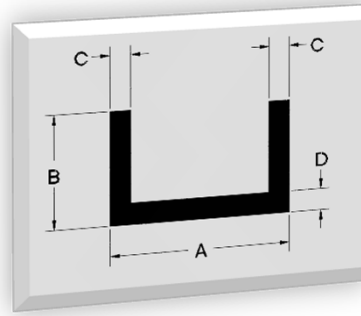

ALL CORNERS =.015" RADIUS

CHANNELS 3-4 SQUARE CORNERS

DIE NUMBER	A	B	C	D	LBS/FT	KG/M
ES05190***	0.500	0.625	0.062	0.062	0.119	0.177
ES05665***	0.500	0.750	0.060	0.060	0.133	0.198
ES05656***	0.625	0.750	0.056	0.056	0.133	0.198
ES05762***	0.750	0.625	0.055	0.055	0.123	0.183
ES05579	0.750	0.750	0.125	0.125	0.295	0.439
ES05562***	0.875	0.625	0.060	0.060	0.142	0.211
ES05838***	1.000	0.750	0.065	0.065	0.182	0.270
ES05738	1.000	0.750	0.125	0.125	0.338	0.502
ES05230	1.000	1.000	0.125	0.125	0.405	0.603
ES05764	1.000	1.500	0.125	0.125	0.553	0.823
ES05927	1.000	2.000	0.125	0.125	0.700	1.042
ES05954***	1.200	0.500	0.050	0.050	0.126	0.187
ES05773***	1.250	0.500	0.062	0.062	0.158	0.235
ES05920	1.500	0.500	0.125	0.125	0.337	0.502
ES05921	1.500	0.750	0.125	0.125	0.412	0.614
ES05768***	1.500	1.000	0.050	0.050	0.204	0.304
ES05667***	1.500	1.000	0.065	0.065	0.258	0.384
ES05831	1.500	1.000	0.125	0.125	0.487	0.725
ES05660	1.500	1.500	0.125	0.125	0.627	0.933
ES05416	1.750	0.750	0.090	0.090	0.326	0.485

***Available in 6063 alloy only (Pricing Premium Applies).

^^^Length restriction in effect.

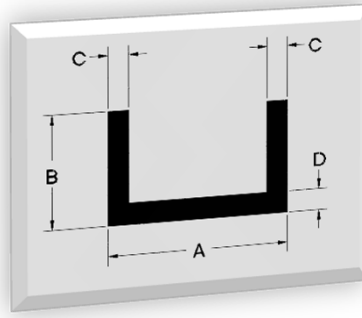

ALL CORNERS =.015" RADIUS

CHANNELS 3-4 SQUARE CORNERS

DIE NUMBER	A	B	C	D	LBS/FT	KG/M
ES05480	1.750	0.750	0.090	0.120	0.381	0.568
ES05415***	1.900	0.825	0.065	0.065	0.262	0.390
ES05683	2.000	0.500	0.125	0.125	0.412	0.614
ES05599	2.000	0.750	0.125	0.125	0.479	0.713
ES05477***	2.000	1.000	0.050	0.050	0.230	0.342
ES05686	2.000	1.000	0.075	0.075	0.341	0.507
ES05095	2.000	1.000	0.125	0.125	0.553	0.823
ES04009	2.000	2.000	0.125	0.125	0.848	1.262
ES05778	2.000	2.000	0.250	0.250	1.650	2.455
ES05739	2.500	1.500	0.125	0.125	0.788	1.172
ES05771	3.000	1.000	0.125	0.125	0.701	1.043
ES05756	3.000	1.250	0.125	0.125	0.788	1.172
ES05615	3.000	2.000	0.188	0.188	1.466	2.181
ES05435	4.000	2.000	0.125	0.125	1.143	1.701
ES05678^^^	4.000	2.000	0.250	0.250	2.213	3.293
ES05104	7.500	0.750	0.090	0.090	0.937	1.394

***Available in 6063 alloy only (Pricing Premium Applies).

^^^Length restriction in effect.

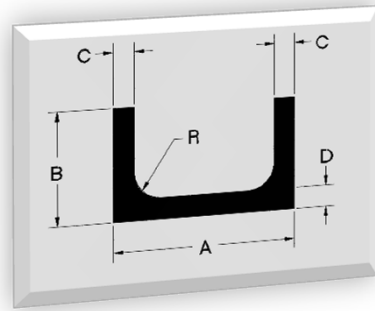

SQUARE CORNERS =.015" RADIUS

CHANNELS 3-5 SQUARE CORNERS, ROUNDED INSIDE

DIE NUMBER	A	B	C	D	R	LBS/FT	KG/M
ES05899	2.000	1.500	0.125	0.125	0.125	0.708	1.054
ES05887	2.250	1.000	0.188	0.188	0.062	0.861	1.281
ES05688	3.000	1.500	0.188	0.188	0.188	1.266	1.883
ES05828	3.000	1.500	0.250	0.188	0.312	1.487	2.213
ES05857	3.000	1.500	0.312	0.250	0.312	1.854	2.760
ES05607^^^	3.000	1.500	0.375	0.375	0.375	2.394	3.563
ES61664	3.000	2.000	0.188	0.250	0.200	1.710	2.545
ES05909^^^	3.000	2.000	0.312	0.250	0.188	2.191	3.261
ES05858^^^	3.000	2.000	0.312	0.250	0.312	2.223	3.308
ES05900^^^	4.000	1.750	0.281	0.250	0.375	2.246	3.342
ES05859^^^	4.000	2.000	0.250	0.187	0.375	2.023	3.011
ES05935^^^	4.000	2.000	0.250	0.250	0.188	2.230	3.319
ES05901^^^	4.000	2.000	0.312	0.250	0.375	2.539	3.779
ES62634^^^	4.000	2.500	0.250	0.250	0.437	2.604	3.875
ES05865^^^	5.000	2.000	0.343	0.281	0.375	3.120	4.644
ES05878^^^	5.000	2.500	0.375	0.250	0.437	3.563	5.302
ES05945^^^	6.000	2.000	0.375	0.281	0.437	3.602	5.361
ES05947^^^	6.000	2.500	0.312	0.250	0.437	3.523	5.243
ES05892^^^	8.000	2.750	0.375	0.250	0.437	4.669	6.948
ES05905^^^	8.000	3.000	0.437	0.281	0.500	5.583	8.309

***Available in 6063 alloy only (Pricing Premium Applies).

^^^Length restriction in effect.

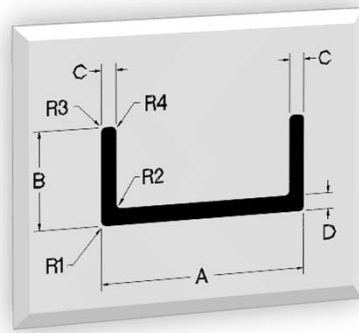

CHANNELS 3-6

ALL ROUNDED CORNERS

DIE NUMBER	A	B	C	D	R1	R2	R3	R4	LBS/FT	KG/M
ES05808	1.750	0.750	0.125	0.125	0.031	0.015	0.031	0.031	0.441	0.657
ES63846 ^{^^^}	5.000	1.500	1.438	0.750	0.031	0.031	0.125	0.125	7.071	10.524

***Available in 6063 alloy only (Pricing Premium Applies).
^{^^^}Length restriction in effect.

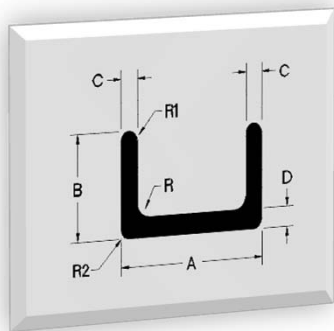

CHANNELS 3-7
ROUNDED INSIDE, FULL ROUNDED CORNERS

DIE NUMBER	A	B	C	D	R	R1	R2	LBS/FT	KG/M
ES05711***	1.688	0.750	0.050	0.050	0.015	FULL	0.062	0.180	0.267
ES05093***	2.000	1.000	0.063	0.063	0.130	FULL	0.030	0.295	0.439
ES07673	4.250	1.620	0.100	0.100	0.056	FULL	0.156	0.847	1.260

***Available in 6063 alloy only (Pricing Premium Applies).
^^^Length restriction in effect.

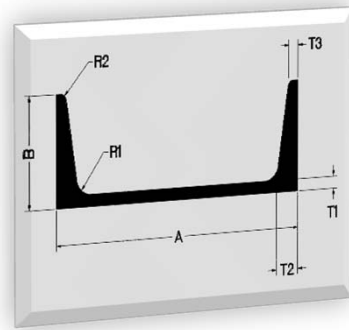

SQUARE CORNERS = .015" RADIUS

MISCELLANEOUS CHANNEL 3-8

DIE NUMBER	A	B	T1	T2	T3	R1	R2	LBS/FT	KG/M
ES05723	3.000	1.410	0.170	0.397	0.170	0.270	0.100	1.506	2.242
ES60046 ^^^	4.000	1.720	0.250	0.400	0.180	0.280	0.110	2.247	3.343
ES04005^^^	4.000	1.720	0.320	0.414	0.180	0.280	0.110	2.556	3.804
ES05993^^^	6.000	1.920	0.200	0.497	0.200	0.300	0.120	2.830	4.212
ES05781^^^	6.000	1.945	0.225	0.497	0.200	0.300	0.120	3.085	4.591
ES04040^^^	6.000	2.034	0.314	0.487	0.200	0.300	0.120	3.704	5.512

***Available in 6063 alloy only (Pricing Premium Applies).
^^^Length restriction in effect.

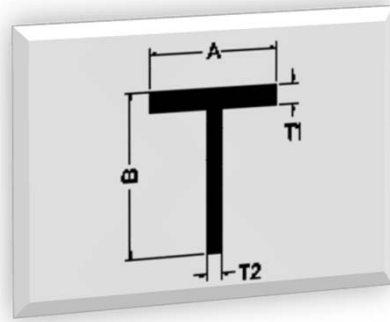

ALL CORNERS = .015" RADIUS

TEE 4-1 SQUARE CORNERS

DIE NUMBER	A	B	T1	T2	LBS/FT	KG/M
ES05625	0.750	0.750	0.125	0.125	0.203	0.302
ES05623	1.000	1.000	0.125	0.125	0.277	0.412
ES05668	2.000	1.000	0.125	0.125	0.424	0.631
ES05624	2.000	2.000	0.125	0.125	0.572	0.851
ES05997	2.000	2.000	0.250	0.250	1.106	1.646

***Available in 6063 alloy only (Pricing Premium Applies).
^^^Length restriction in effect.

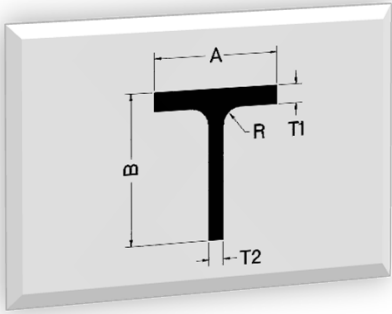

SQUARE CORNERS =.015" RADIUS

TEE 4-2
SQUARE CORNERS, ROUNDED INSIDE

DIE NUMBER	A	B	T1	T2	R	LBS/FT	KG/M
ES05693	1.500	1.500	0.188	0.188	0.188	0.642	0.955
ES04033^^^	3.000	3.000	0.375	0.375	0.375	2.560	3.810
ES05784	4.000	2.000	0.250	0.250	0.250	1.728	2.571
ES05783^^^	4.000	3.000	0.250	0.250	0.250	2.023	3.010

***Available in 6063 alloy only (Pricing Premium Applies).
^^^Length restriction in effect.

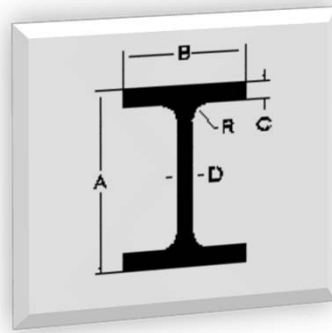

SQUARE CORNERS =.015" RADIUS

T-BEAMS 4-3

SQUARE CORNERS, ROUNDED INSIDE

DIE NUMBER	A	B	C	D	R	LBS/FT	KG/M
ES04021^^^	4.000	3.000	0.312	0.188	0.375	3.100	4.613
ES05877^^^	5.000	3.500	0.312	0.250	0.437	4.061	6.044
ES04028^^^	6.000	3.000	0.312	0.250	0.375	3.937	5.859
ES05893^^^	6.000	3.500	0.375	0.250	0.438	4.840	7.203

***Available in 6063 alloy only (Pricing Premium Applies).
^^^Length restriction in effect.